

# 貴金属合金多接点ワイパ採用により、信頼性に優れるRJシリーズ 1回転型サーメットリマ

## SINGLE TURN CERMET TRIMMERS **RJ-6**

RoHS 指令対応 RoHS compliant

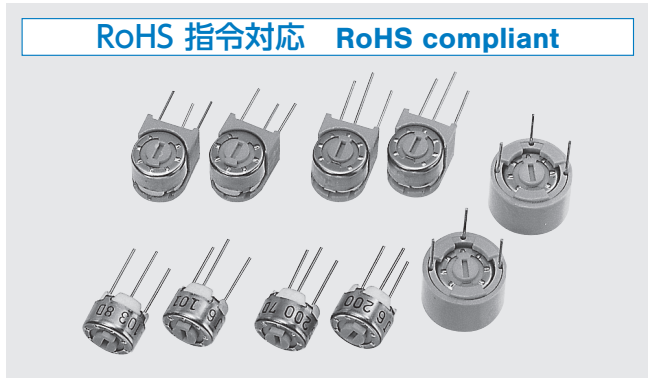

### ■ 特長 FEATURES

- RoHS 指令対応
- 10 Ω ~ 5 MΩ の幅広い抵抗値範囲
- 接触抵抗変化 (C.R.V.) は 1 % 以下
- 貴金属合金多接点ワイパ採用
- 樹脂材料は、UL 難燃クラス 94V-0 認証品を採用しております
- RoHS compliant
- Wide resistance range from 10 Ω to 5 MΩ
- Low contact resistance variation (1 % maximum)
- Precious metal alloy wiper
- Resin material is UL Recognized 94V-0

内部構造図 INTERNAL STRUCTURE

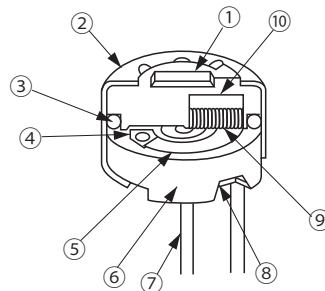

名称 Part name	材料 Material
① ロータ Rotor	PBT (ポリブチレンテレフタレート) Polybutyleneterephthalate
② カバー Cover	ステンレス Stainless steel
③ Oリング "O" ring	シリコンゴム Silicone rubber
④ 電極体 Electrode	Ag-Pd サーメット Ag-Pd cermet
⑤ 抵抗体 Resistive element	RuO <sub>2</sub> サーメット RuO <sub>2</sub> cermet
⑥ ベースエレメント Base element	セラミック Ceramic
⑦ 端子 Terminal pin	ニッケル、金めっき Nickel, Gold-plated
⑧ 接着剤 Adhesive	エポキシ Epoxy
⑨ ワイパ (摺動子) Wiper	多元合金 Multi metal alloy
⑩ ゴム板 Rubber cushion	シリコンゴム Silicone rubber

### ■ 型式表示 PART NUMBER DESIGNATION

R J - 6 P 1 0 k Ω ( 1 0 3 )

シリーズ名 Series name

抵抗値記号 Resistance code

製品形状 Product shape

抵抗値 Resistance value

P : 上面調整 Top adjustment S : 側面調整 Side adjustment









W : 上面調整 Top adjustment X : 側面調整 Side adjustment

F : 裏面調整 Rear adjustment

※ご注文に際しては、型式一覧表をご確認ください。

Please refer to the LIST OF PART NUMBERS when placing orders.

## 型式一覧表 LIST OF PART NUMBERS

調整方向 Adjustment position	端子形状 (上面図) Shape of terminal (Top view)	包装形態 Form of packaging	包装数量 Pieces in package
		ポリ袋 Plastic bag	
上面調整 Top adjustment 		RJ-6P	50 pcs./pack
		RJ-6W	
側面調整 Side adjustment (↑調整面) (↑Adjustment direction) 		RJ-6S	
		RJ-6X	
裏面調整 Rear adjustment 		⊖ RJ-6F	

## 電気的特性 ELECTRICAL CHARACTERISTICS

公称抵抗値範囲 Nominal resistance range	10 Ω ~ 5 MΩ
抵抗値許容差 Resistance tolerance	± 10 %
定格電力 Power ratings	0.5 W (70 °C) 0 W (120 °C)
抵抗変化特性 Resistance law	直線性 (B) Linear law
最大入力電圧 Maximum input voltage	DC200 V 又は定格電力の何れか小さい方 DC200 V or power rating, whichever is smaller
最大ワイパ電流 Maximum wiper current	100 mA 又は定格電力の何れか小さい方 100 mA or power rating, whichever is smaller
有効電氣的回転角度 Effective electrical angle	230 ° (1 turn)
残留抵抗値 End resistance	1 % 又は 2 Ω の何れか大きい方以下 1 % or 2 Ω, whichever is greater
接触抵抗変化 C.R.V.	1 % 又は 3 Ω の何れか大きい方以下 1 % or 3 Ω, whichever is greater
使用温度範囲 Operating temp. range	-55 ~ 120 °C
抵抗温度係数 Temp. coefficient	10 Ω, 20 Ω, 5 MΩ: ± 250 10 <sup>-6</sup> /°C maximum 50 Ω ~ 2 MΩ: ± 100 10 <sup>-6</sup> /°C maximum
絶縁抵抗 Insulation resistance	1000 MΩ minimum (DC500 V)
絶縁耐圧 Dielectric strength	AC900 V, 60 s
質量 Net weight	Approx. 0.60 g (RJ-6P, W) Approx. 0.80 g (RJ-6S, X) Approx. 1.01 g (RJ-6F)

## 〈公称抵抗値 Nominal resistance values〉

⊖10 Ω	⊖20 Ω	50 Ω	100 Ω	200 Ω	500 Ω	1 k Ω	2 k Ω	5 k Ω	10 k Ω
20 k Ω	⊖25 k Ω	50 k Ω	100 k Ω	200 k Ω	⊖250 k Ω	500 k Ω	1 M Ω	2 M Ω	⊖5 M Ω

Fig. 1

※ ご注文に際しては、〈公称抵抗値〉(Fig. 1) について上記すべての組み合わせを用意しています。

※ ご注文に際しては、上記型式をご確認ください。

※ The above part numbers are all available with the respective combination of <Nominal resistance values> (Fig. 1).

※ Verify the above part numbers when placing orders.

⊖印の型式、公称抵抗値は受注生産となります。

The products indicated by ⊖ mark are manufactured upon receipt of order basis.

## 機械的特性

### MECHANICAL CHARACTERISTICS

機械的回転角度 Mechanical angle	270 ° (1 turn)
回転トルク Operating torque	2~15 mN·m {20 ~ 153 gf·cm}
回転止強度 Stop strength	50 mN·m {510 gf·cm} minimum
回転寿命 Rotational life	200 cycles 10 Ω ~ 200 Ω [ΔR/R ≤ ± (0.5 Ω + 3 %)] 500 Ω ~ 5 MΩ [ΔR/R ≤ ± (0.5 Ω + 2 %)]
端子強度 Terminal to strength	10 N {1.02 kgf} minimum (引張り強さ Tensile strength)
操作部の押し強さ Thrust rotor	10 N {1.02 kgf} minimum
はんだ付け性 Solderability	245 ± 3 °C, 2 ~ 3 s

{ } : 参考値 Reference only

## 環境特性

### ENVIRONMENTAL CHARACTERISTICS

試験項目 Test item	試験条件 Test conditions	仕様 Specifications
熱衝撃 Thermal shock	-65 ~ 125 °C (0.5 h), 5 cycles	[ΔR/R ≤ 1 %] [S.S. ≤ 1 %]
耐湿性 Humidity	-10 ~ 65 °C (相対湿度 Relative humidity 80 ~ 98 %), 10 cycles, 240 h	[ΔR/R ≤ 1 %]
耐衝撃性 Shock	981 m/s <sup>2</sup> , 6 ms 6 directions for 3 times each	[ΔR/R ≤ 1 %] [S.S. ≤ 1 %]
耐振動性 Vibration	振幅 (Amplitude) 1.52 mm or 加速度 (Acceleration) 196 m/s <sup>2</sup> , 10 ~ 2000 Hz, 3 directions, 12 times each	[ΔR/R ≤ 1 %] [S.S. ≤ 1 %]
負荷寿命 Load life	70 °C, 0.5 W, 1000 h	[ΔR/R ≤ 2 %] [S.S. ≤ 1 %]
低温動作 Low temp. operation	-55 °C, 2 h	[ΔR/R ≤ 1 %] [S.S. ≤ 2 %]
高温放置 High temp. exposure	120 °C, 250 h	[ΔR/R ≤ 2 %] [S.S. ≤ 2 %]
耐水、密閉性 Immersion seal	85 °C, 60 s	もれ無し (連続気泡無し) No leaks (No continuous bubbles)
はんだ耐熱性 Soldering heat	フロー : Flow 260 ± 3 °C, 5 ~ 6 s, two times maximum 手はんだ : Manual soldering 380 ± 10 °C, 3 ~ 4 s	[ΔR/R ≤ 1 %]

ΔR/R : 全抵抗値変化 Change in total resistance  
S.S. : 設定安定度 Setting stability

# RJ-6

## CERMET TRIMMERS

### 最大入力定格 MAXIMUM INPUT RATINGS

公称抵抗値 Nominal resistance values (Ω)	抵抗値記号 Resistance code	最大入力電圧 Maximum input voltage (V)	最大ワイパ電流 Maximum wiper current (mA)
⊖ 10 ⊖ 20 50 100 200 500	100 200 500 101 201 501	1.00 2.00 5.00 7.07 10.0 15.8	100 100 100 70.7 50.0 31.6
⊖ 1 k 2 k 5 k 10 k 20 k 25 k 50 k	102 202 502 103 203 253 503	22.4 31.6 50.0 70.7 100 112 158	22.4 15.8 10.0 7.07 5.00 4.48 3.16
⊖ 100 k 200 k 250 k 500 k 1 M 2 M 5 M	104 204 254 504 105 205 505	200 200 200 200 200 200 200	2.00 1.00 0.80 0.40 0.20 0.10 0.04

⊖印の公称抵抗値は受注生産となります。  
The products indicated by ⊖ mark are manufactured upon receipt of order basis.

### 外形寸法図 OUTLINE DIMENSIONS

Unless otherwise specified, tolerance: ± 0.3 (Unit: mm)

#### ● RJ-6P 上面調整 Top adjustment

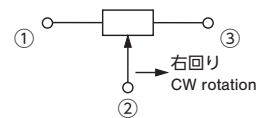
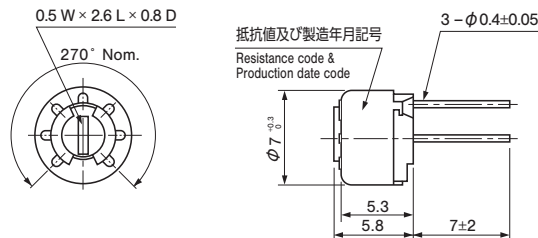

#### ● RJ-6W 上面調整 Top adjustment

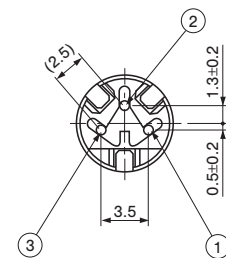
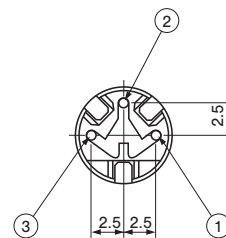
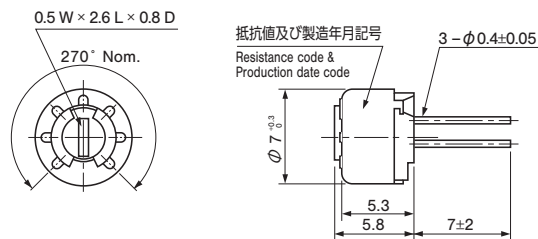

★P型とピンピッチが異なります。  
Pin pitch in W type is different from P type.

#### ● RJ-6S 側面調整 Side adjustment

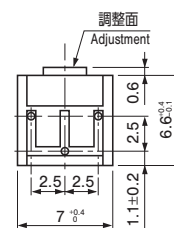
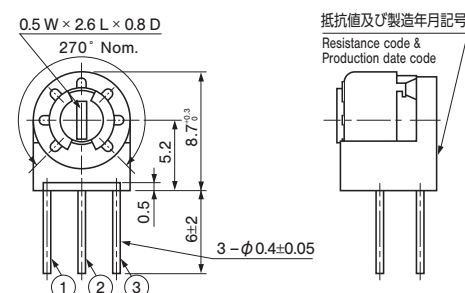

### 外形寸法図 OUTLINE DIMENSIONS

Unless otherwise specified, tolerance:  $\pm 0.3$  (Unit: mm)

#### RJ-6X 側面調整 Side adjustment

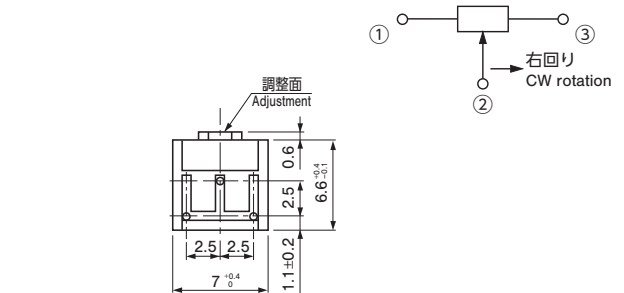
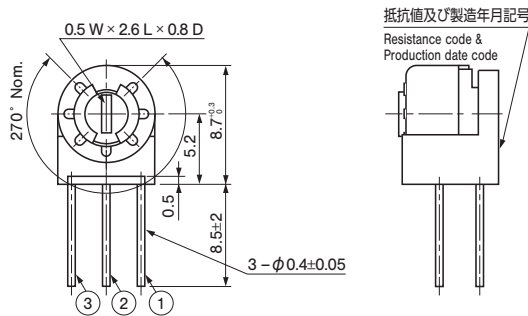

★ S型とピン位置及びストップパ位置が異なります。  
Pin position & stopper position of X type are different from S type.

#### RJ-6F 裏面調整 Rear adjustment

<受注生産品 Semi-standard products >

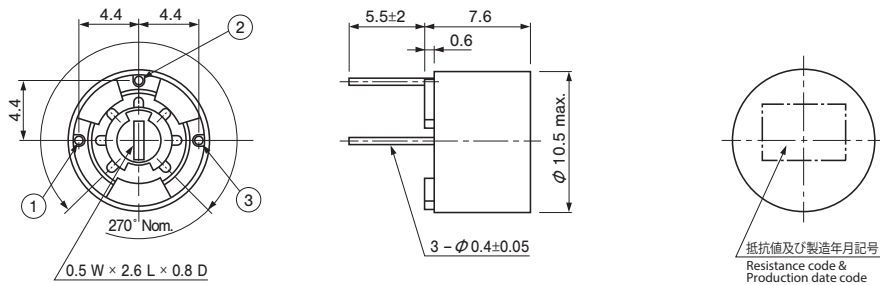

### 包装仕様

#### <ポリ袋の包装仕様>

- ポリ袋での包装は、50個 / 袋となります。
- ポリ袋の箱詰めは、200個 (RJ-6Fは100個) を製品箱に包装致します。

### PACKAGING SPECIFICATIONS

#### <Bulk pack specifications>

- Unit of bulk pack in a plastic bag is 50 pcs. per pack.
- Boxing of bulk in a plastic bag is performed with 200 pcs. (RJ-6F is 100 pcs.) per box.