

Nidec

HIGH VACUUM CORRESPONDENCE
SMALL SIZE PRESSURE GAUGE

PG-35L

CE marking
(Compliance with EMC Standards)

INSTRUCTION MANUAL Ver.2.2

Thank you for purchasing a
NIDEC COPAL ELECTRONICS CORP. product.
In order to use the product correctly and most
appropriately, please completely read this manual before
use and keep it for future reference.

For more detailed information please ask for the nearest
distributor or the following sales center.

NIDEC COPAL ELECTRONICS CORPORATION

Nishi-Shinjuku Prime Square., 7-5-25
Nishi-Shinjuku Shinjuku-ku Tokyo 160-0023, Japan
<https://www.nidec-copal-electronics.com>

⚠ Important Information and Warnings

- ① The type of pressure media for PG-35L should be used liquid and gas that don't corrode for SUS316L.
- ② For stability, use a regulated direct current power supply.
Surge absorbing devices (diodes, varistors, etc.) are necessary if inductive loads such as relays or solenoids are connected to the same circuit as the PG-35L.
If using a DC power supply unit such as a switching power supply, the FG terminal should be earthed. Do not wire in parallel to high tension cables or power lines, or use cable ducts which contain high tension cables or power lines.
- ③ Be careful not to crimp any wires during handling, or put any pressure on the display area of the main body while assembling piping.
- ④ Use pH neutral detergents to clean the body. Do not use solvents such as thinners.
- ⑤ This product is dust proof and drip proof (IP65 of IEC standards) and is not suitable for use in environments requiring higher standards.
Also, do not use this product in an environment with a possibility of product being covered by liquids other than water (Such as oil, solvent, and etc.) and outdoor.
- ⑥ Do not use pointed objects such as pens to press the setting buttons on the display panel, as this may push holes in the setting buttons and damage them.
- ⑦ Do not insert wires, etc. in the pressure port, as this may damage the internal diaphragm and cause malfunctioning.
- ⑧ gasket type:
Do not touch or scratch the edge of the fitting, as this may damage the sealing and cause leakage.
- ⑨ The PG-35L do not have an explosion proof structure. Do not use it for the detection of flammable gases.
- ⑩ When analog output is supplied to a noise-sensitive device, a low-pass filter is requested in a customer's circuit.
- ⑪ Countermeasures for noise interference:
Please connect either the shield wire or the metal part of the product to frame ground (FG) of the power source.
- ⑫ In case a wire extension is needed, please use a shielded wire.

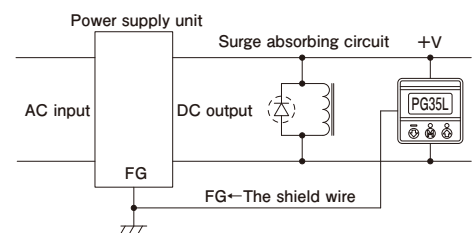

Specifications

Model	PG-35L		
	102R	103R	
Type	Gauge pressure		
Rated pressure range	-100~100kPa	-100~1000kPa	
Maximum pressure	200kPa	1500kPa	
Break-down pressure	300kPa	2000kPa	
Acceptable media	Liquids or gases that do not corrode SUS316L		
Operating voltage	10.8~30VDC (including ripple)		
Current consumption	50mA maximum		
Switch outputs	Two outputs NPN/PNP: Transistor open collector Switch rating: 30VDC/100mA maximum Residual voltage: 1.2V maximum (NPN) / 2.2V maximum (PNP) at 100mA.		
	Hysteresis	0~300 counts setting (adjustable)	
	Repeatability	±0.2%FS±1 digit	
	Response	Approx.5ms (Digital Filter:"F-0")	
	Short circuit protection		
	Exists		
Analog output	Output voltage 1~5V / Pin(L) ~Pin(H) , Output impedance : 10kΩ , Resolution : 1 / 204 Only R / G mode is available on 103R.		
	Output mode	Pressure range Pin(L) ~Pin(H)	
	R	-100~100kPa	
	G	0~100kPa	
	V	0~100kPa	
	Output mode	Output voltage accuracy Vzero (upper) / Vspan (Lower) (Vzero : Pin=0, Vspan : Pin=0~Pin(H))	
	R	3±0.2V 2±0.2V	
	G	1±0.2V 4±0.2V	
	V	1±0.2V 4±0.2V	
Display	Full 3 digit LED display (display cycle:4 times per second)		
	Negative pressure display	- LED is lit	
Display accuracy	±1%FS		
Operation display	SW1 LED (green) and SW2 LED (red) light up when switch outputs are ON		
Operating conditions	IP protection	Meets IP65 (pressure gauge main body) of IEC	
	Operating temperature	-10 ~50°C (storage -20~70°C)	
	Operating humidity	35~85% RH	
	Insulation resistance	50MΩ minimum at DC125V between bundled leads and pressure port	
	Dielectric strength	One minute at DC125V between bundled leads and pressure port (1mA maximum leakage)	
	Vibration resistance	10~500HZ 1.5mm maximum / 98.1 ^m / s ² ,three directions, two hours each	
	Shock resistance	490m/s, three directions, three times each	
EMC	EMI : EN5501 Group 1, Class B / 1998 EMS : EN61326-1 / 1997 : The permissible change of display counts, set value of switch output and zero / span voltage of analog output during the test not exceed ±5%FS.		
Thermal error	±3%FS (0~50°C)		
Enclose liquid	Nonexistence		
Usable pressure in vacuum	Above 1.4×10 ⁻³ Pa abs		
Fitting part types	R1/4, G1/4, gasket fitting 9/16-18UNF		
Materials at pressure receiving area	SUS316L		
Net Weight	150±30g (incl. 2m cable)		
Accessories	O-ring (G1 / 4 : P15)		

Output Electrical Diagram (Wire Colors correspond to IEC standards)

NPN Open Collector Output Model

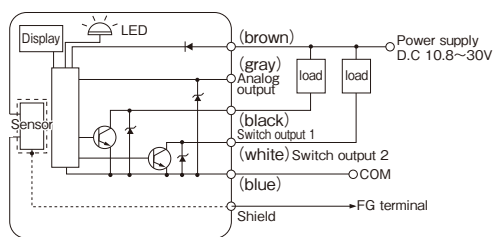

PNP Open Collector Output Model

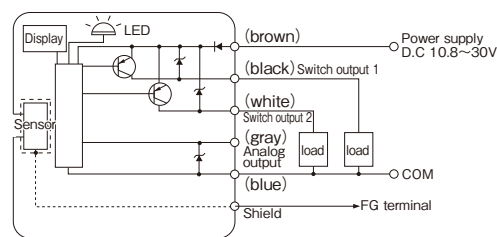

Function Names

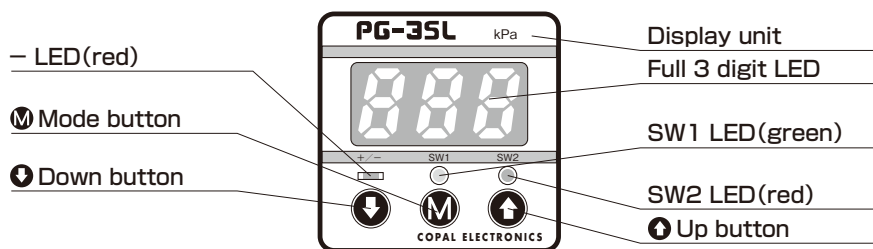

Operating Procedures

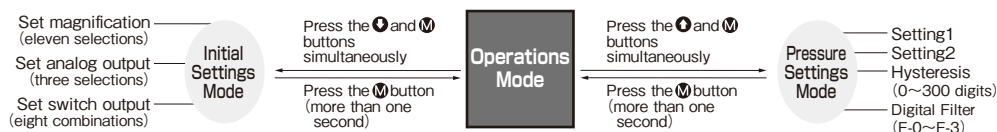

When the power is switched on, the Operations Mode is automatically selected. Settings remain in effect after switching off the power.

Initial Settings Mode

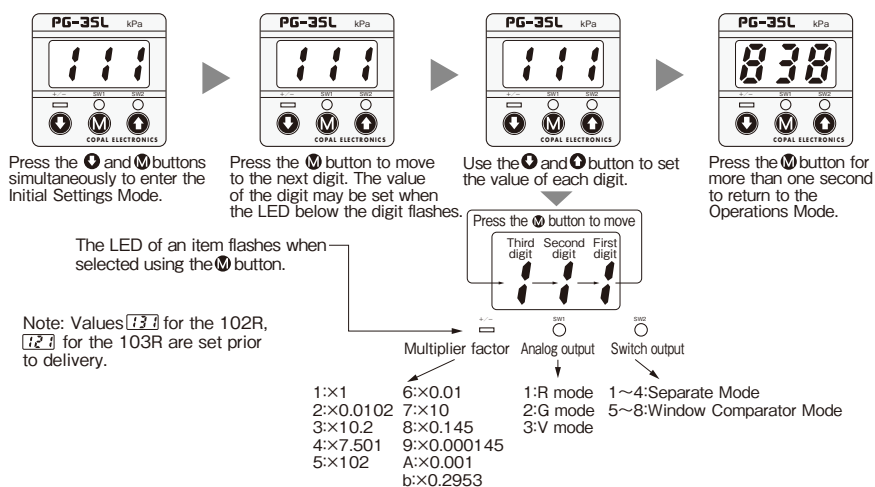

Multiplier factor Setting

The multiplier factor setting is determined by the value of the third digit : the red -LED should be flashing during the setting.

Value selected	Multiplier factor	Pressure range (-Pr~+Pr)	
		102R	103R
1	×1	-99.9~99.9	-100~999
2	×0.0102	-999~999	-1.02~9.99
3	×10.2	-750~750	
4	×7.501		-1.00~9.99
5	×102		
6	×0.01	-999~999	
7	×10	-14.5~14.5	
8	×0.145		-14~145
9	×0.000145		
A	×0.001		-0.10~1.00
b	×0.2953	-29.5~29.5	-29~295

Sections containing an oblique stroke are multiplier factor that cannot be selected because of resolving power or display digits. (Values will not be displayed automatically.)

An example of setting "4".

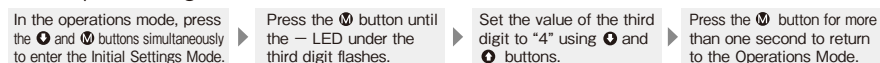

Note: "1" is set prior to delivery.

※ Change of magnification setting is effective only for pressure reading. Set values for switching are not scaled automatically.

Analog Output Setting

The analog output setting is determined by the value of the second digit : the green SW1 LED should be flashing during the setting.

Value selected	Mode	-Pr		0	+Pr	
		←	→		←	→
1	R mode (Compound pressure output)	1V		(Vzero)	5V	
2	G mode (Positive pressure output)			1V	5V	
3	V mode (Negative pressure output)	5V		1V		

An example of setting the R mode in the 102R range.

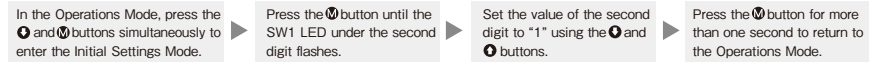

Notes: V mode for 102R are set prior to shipment. R / G mode for 103R can only be selected.

Switch Output Setting

The switch output setting is determined by the value of the first digit : the red SW2 LED should be flashing during the setting.

Value selected	Output Mode	SW1 output				SW2 output			
		Separate		Window comparator		Separate		Window comparator	
		H	L	A	B	H	L	A	B
1									
2									
3									
4									
5									
6									
7									
8									
		Setting 1		Minimum: Setting 1 Maximum: Setting 2		Setting 2		Minimum: Setting 1 Maximum: Setting 2	
		Note 1		Note 2		Note 1		Note 2	

There are four operation modes. These are shown in the diagrams below.

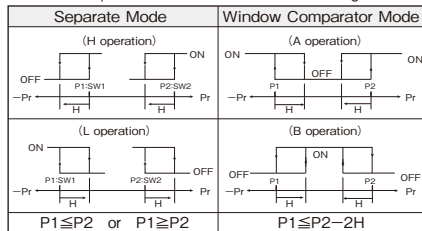

Note 1. In the Separate Mode, setting 1 corresponds to SW1, and Setting 2 corresponds to SW2.
Note 2. In the Window Comparator Mode, the minimum value for SW1 and SW2 corresponds to Setting 1 and the maximum value corresponds to Setting 2.

Window Comparator Mode

(An example of setting the value "7" for the mode shown in the diagram.)

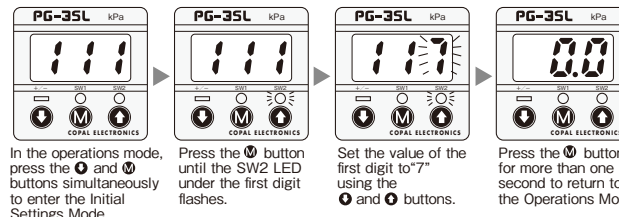
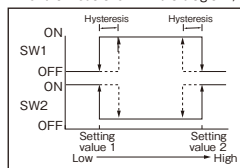

Pressure Settings Mode

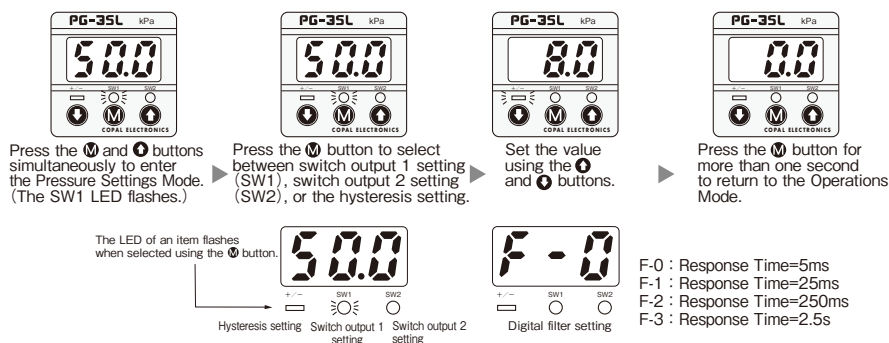

Switch Output Setting

To set switch output 1 the SW1 LED should be flashing. (To set switch output 2 the SW2 LED should be flashing.)
An example of setting 60kPa for switch output 1 (SW1 LED is flashing) with 102R.



Note: +50%F.S. is set prior to delivery.

Hysteresis setting

To set hysteresis the "-"LED should be flashing.
An example of setting a hysteresis value of 8.0kPa with the 102R (kPa).

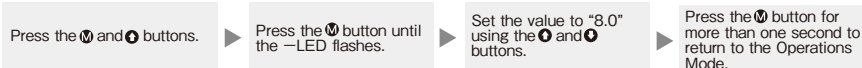

Note: 20digits is set prior to delivery.

Digital Filter setting

To set Digital Filter all LED should be not flashing. An example of setting 2.5s response time by Digital Filter.



Note: "F-0" is set prior to delivery.

Troubleshooting

If the following error messages are displayed, follow the procedures in the table.

Display and problem	Cause	Solution
E-1	Output current is exceeding 100mA.	Turn off the power and verify the load connected switch output 1 and 2.
E-2	Pressure was applied at the zero point adjustment.	Press M button and return the applied pressure to the atmospheric pressure and try zero-point adjustment again.
E-3,E-4	Failure of the internal circuit.	Please contact us. Please use a regulated DC power supply and measures for the power line noise.
999 Flashing	Pressure values exceed the display range.	Normal state
Flashing of the pressure value	Pressure values exceed the rated pressure range.(110%FS)	Normal state
Black out of the display	Non-display mode	Normal state (See Non-display mode.)
Disable the key operation	Key protection mode	Normal state (See Key protection mode.)

Zero point Adjustment

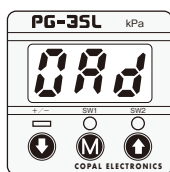

Pressing the M, +/- and buttons simultaneously in the Operations Mode displays '0.00' on the screen. One second later this change to '0' than the +/- and M buttons are released. (If the pressure port is opened to the atmosphere.)

Note: You have to adjust Zero under open air condition.
Otherwise you can be seen E-2 error as you adjusted Zero with residual pressure.

Others

Tube at atmospheric pressure intake

If there is any possibility that the sensor may become wet with oil or water, which may enter the case through the air intake, connect a silicon tube, or similar, to the intake and position the end of the tube in a suitably safe place. Be sure not to bend the tube or block the end of the tube.

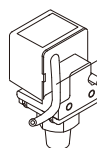

Example of a tube with external diameter of $\phi 4$ and internal diameter of $\phi 2.5$

Piping

Use a wrench on a hexagon of fitting part. Do not hold the main body when tightening.

■ Non-Display Mode

<Non-Display [Temporary] Mode>

- When the keys are not operated for more than 10 seconds during Operation Mode, the system will automatically select Non-Display [Temporary] Mode and the display will turn off.
- Decimal point LED shown in the figure below will blink during Non-Display [Temporary] Mode.
- Using the EEPROM, the PG-35L can retain preset values even if the power is turned off.
- If an error message is detected, the display will comeback and show the error message.
- You can change any functions during Non-Display [Temporary] Mode.

(How to set)

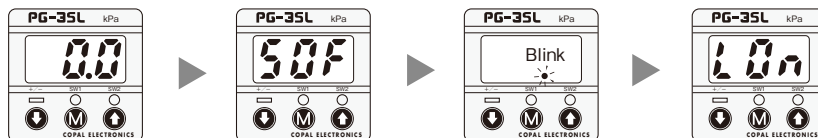

- To enable Non-Display [Temporary] Mode, press **M** key for more than 4 seconds. **5.0F** will be displayed and Non-Display [Temporary] Mode will be set. After 10 seconds, display will go off.
- To disable Non-Display [Temporary] Mode, press **M** key for more than 4 seconds. **1.0n** will be displayed and Non-Display [Temporary] Mode will be canceled.

<Non-Display [Full-time] Mode>

- In Non-Display [Full-time] Mode, the display will be turned off and the Keys will be locked.
- Decimal point LED shown in the figure below will light up during Non-Display [Full-time] Mode.
- Using the EEPROM, the PG-35L can retain the preset values even if the power is turned off.
- If an error message is detected, the display will comeback and show the error message.
- You cannot change any functions during Non-Display [Full-time] Mode.

(How to set)

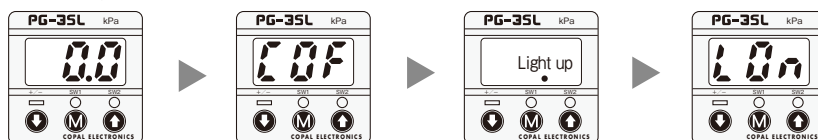

- To enable Non-Display [Full-time] Mode, press **M** key for more than 4 seconds. **1.0F** will be displayed and Non-Display [Full-time] Mode will be set. Display will turn off in a second.
- To disable Non-Display [Full-time] Mode, press **M** key for more than 4 seconds. **1.0n** will be displayed and Non-Display [Full-time] Mode will be canceled.

■ Key Protection Mode

<Key Protection Mode>

- Key Protection Mode is used to lock the front panel key in order to prevent preset values from being accidentally changed.
- Using EEPROM, the PG-35L can retain the preset values even if the power is turned off.

(How to set)

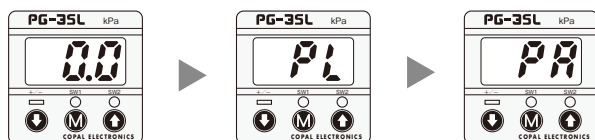

- To enable Key Protection Mode, press **M** key for more than 4 seconds. **PL** will be displayed and the keys will be locked.
- To disable Key Protection Mode, press **M** key for more than 4 seconds. **PR** will be displayed and the keys will be unlocked.

Outline Dimensions (Unit : mm)

■ PG-35L Outline Dimensions

Fitting part:R2 type

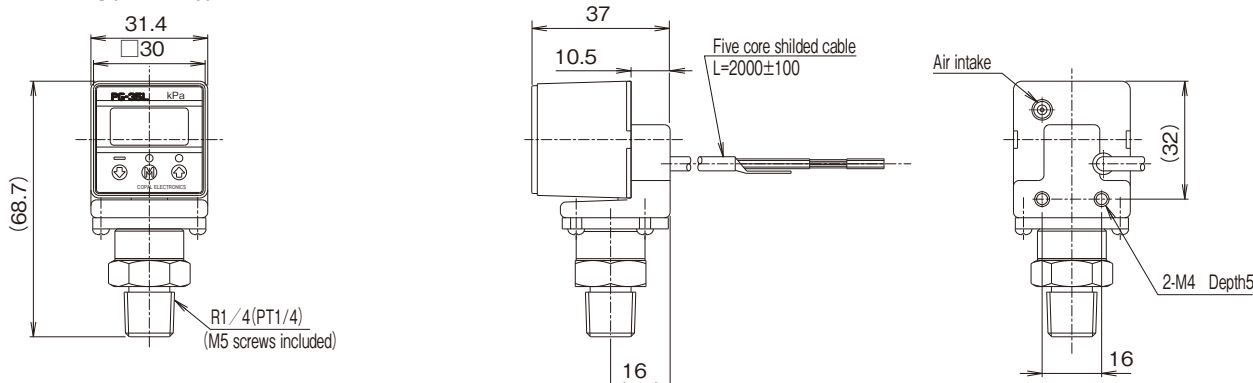

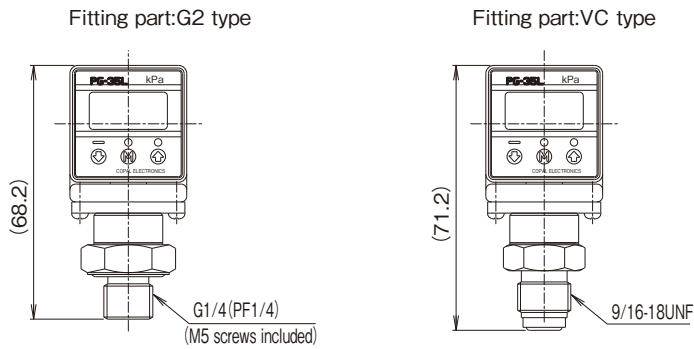

Brackets (Option)

■PG-35L Holder cover set (sold separately)

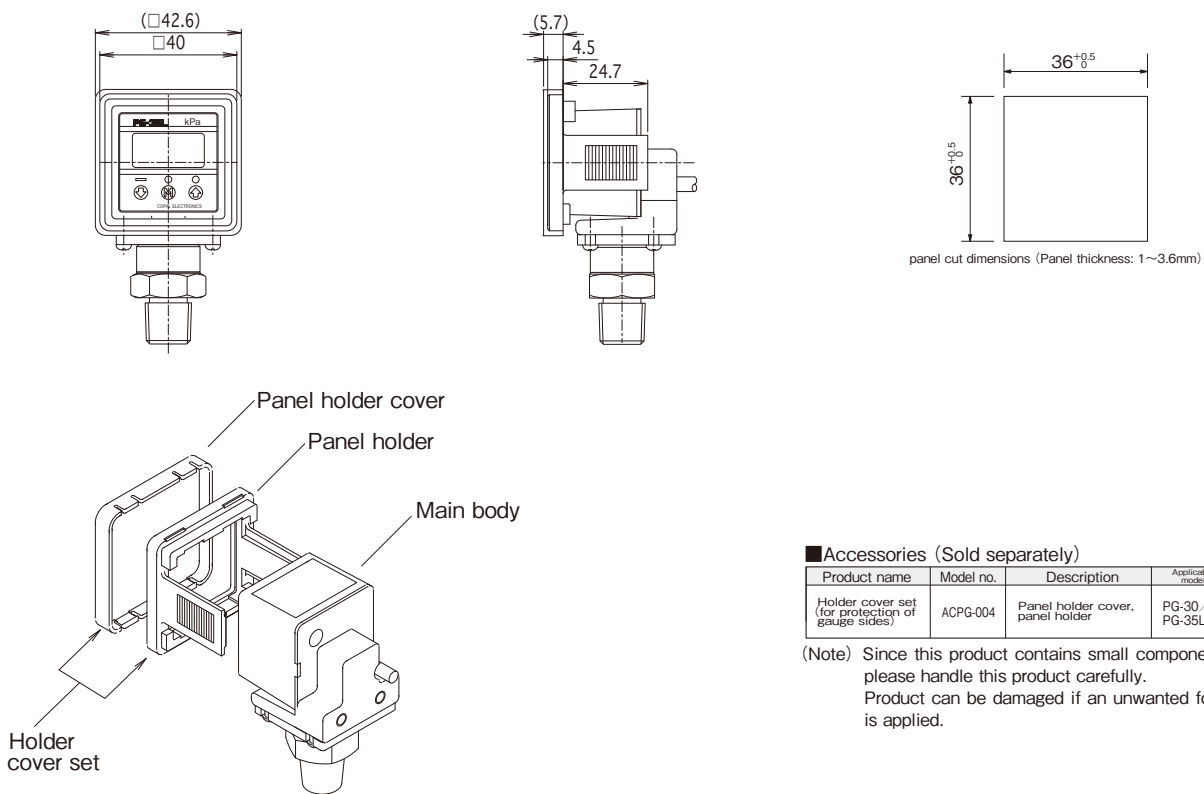

■Accessories (Sold separately)

Product name	Model no.	Description	Applicable model
Holder cover set (for protection of gauge sides)	ACPG-004	Panel holder cover, panel holder	PG-30 / 35 PG-35L

(Note) Since this product contains small components, please handle this product carefully. Product can be damaged if an unwanted force is applied.

Model Numbers

