

Nidec

DIGITAL PRESSURE GAUGE

PG-208

INSTRUCTION MANUAL Ver.9.0

Thank you for purchasing a
NIDEC COMPONENTS CORP. product.
For proper and optimal use of the product, please read
this manual thoroughly before using.
Keep this manual for future reference.

For more detailed information please ask for the nearest
distributor or the following sales center.

NIDEC COMPONENTS CORPORATION

Nishi-Shinjuku Prime Square bldg., 7-5-25
Nishi-Shinjuku, Shinjuku-ku, Tokyo 160-0023, Japan
Phone: +81-3-3364-7055 Fax: +81-3-3364-7098
URL: <https://www.nidec-components.com>



This caution mark describes when there is a possibility that user may suffer from damage or physical damage may occur if the product is used improperly.



WARNING

These products (pressure sensors, pressure switches, pressure gauges, pressure indicators, leakage sensors, etc.) are designed and manufactured as general industrial parts. Therefore, a person with sufficient knowledge and experience shall confirm the conditions and environments described in the catalog, specifications, and instruction manual of each product, check the suitability of the product for the machine, device, or system which you use, and ensure safety before use.

These products are not intended to be used for applications particularly requiring high reliability (These include, but are not limited to, nuclear power control, aerospace and military purposes).

The details of warranty shall be as per the descriptions in this document and we shall not be liable for any damage on you resulting from the use of any equipment or device (including control systems) which is not in accordance with this document (hereinafter referred to as "use in violation"). In the case where you resell our products, we shall not be liable for any damage on a third party resulting from use in violation by the third party, and even if we make payment to the third party in connection with such use in violation regardless of the name by which such payment may be called, we may demand the whole amount thereof from you.

§ 1. Handling Note

CAUTION This caution mark describes when there is a possibility that user may suffer from damage or physical damage may occur if the product is used improperly.

CAUTION

- (1) Diaphragm
Do not touch or scratch the diaphragm at the edge of the fitting, as this may alter the performance characteristics or damage the diaphragm, and cause malfunctioning.
- (2) Piping for stand-alone type
For piping, use the hexagonal portion of the pressure port for driving.
- (3) Media to be used
The Pressure Gauge should be used for fluids that cannot corrode the diaphragm of SUS316L, pressure port of SUS 316 and O-ring of fluoro rubber.
- (4) Excessive pressure
The pressure to be measured is within the specified range.
- (5) Internal battery
 - ① Replace battery with Toshiba Battery Co., Ltd./ERVM3.6V/lithium battery only. Use of another battery may present a risk of fire or explosion. If you need replace battery, please place an order with us.
 - ② When "LOBAT" sign is displayed, the battery should be replaced.
 - ③ The battery used in this device may present risk of fire of chemical burn if mistreated. Do not recharge, disassemble, heat above 100°C(212°F), or incinerate.
 - ④ Dispose of used battery promptly. Keep away from children. Do not disassemble and do not dispose of in fire.
- (6) Maintenance
If the Pressure Gauge gets dirty, wipe it off with hardly squeezed cloth containing a neutral detergent. Do not use any thinner and benzene.
- (7) Protection against noises
 - ① Noises having mixed in the switch output or power line may cause the Pressure Gauge to change the pressure indication, malfunction or be broken. Take some measure to put the Pressure Gauge away from power line or use shielded wire. It is effective to ground the Pressure Gauge.
 - ② If the switch output has an induction load such as relay or solenoid connected to it, it should have a surge absorber circuit put in it. The relay contacts should have a contact preventive circuit put in it to prevent noises from being generated.
- (8) Prohibition of short-circuiting the switch terminals
Do not short-circuit the switch output terminal to any power terminal. The internal circuit may be broken.

§ 2. TRANSPORTATION & STORAGE

- (1) The product, which is a precision instrument, must be taken special care not to be damaged by impact nor by being dropped when it is transported and in storage.
- (2) The product must be avoided in storage where is dusty, dripping and vibrated.

§ 3. Specification

(1) Model

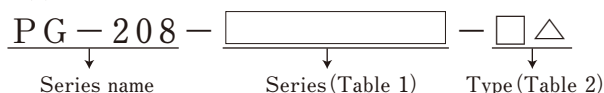

Table 1

SERIES	PRESSURE RANGE	MAX PRESSURE	Break-down Pressure	RESOLUTION	UNIT
102G	0~1.000	2	3	0.001	kgf/cm ²
102GP	0~100.0	200	300	0.1	kPa
102VP	0~-100.0	200	300	0.1	kPa
102VH	0~-735 *	1471	2205	1	mmHg
103G	0~10.00	20	30	0.01	kgf/cm ²
103GP	0~1000	2000	3000	1	kPa
103GMP	0~1.000	2.0	3.0	0.001	MPa

* Measurement can be made upto “-760mmHg” for 102VH.
 (Accuracy not guaranteed beyond the rated pressure.)

Table 2

TYPE	SWITCH OUTPUT	OPTIONAL OUTPUT	POWER SOURCE
-S	HI, LO	-	Internal lithium battery
-3-S	HI, LO	Voltage	External 5~24 Vdc

- (2) Measurement …Gauge pressure.
- (3) Indication …3-1/2 digits, 000~1999Max, digital LCD display.
- (4) Indication …Around 3 times/sec.
- (5) Accuracy …±0.5% F.S. ±2digit (at25°C ±5°C)
- (6) Temperature characteristics
 at zero point ; ±0.1% F.S./°C ±2digit
 in SPAN ; ±0.05% Reading/°C ±2digit
- (7) Switching features
 Number of set points …Two, HI and LO, activated at upper limit.
 Set range divisions …000~1000, HI and LO.
 Setting method …With trimmer each for HI and LO.
 Set value indication can be made to time with setting switch.
 Operating accuracy …Within ±3 divisions from indication value.
 Difference …Within 4 divisions, fixed.
 Output system …NPN open collector of 30Vdc and 40 mA at max.
 Operating indication …“H” in HI mode or “L” in LO mode at ON output.
- (8) Operating temperature …0~50°C
 humidity …35~85% RH, no sweating allowed.
- (9) Storage temperature …-20~70°C, with lower humidity than 65%RH.
- (10) Net weight …Net weight, Around 385g.
- (11) Pressure port …G3/8 (PF3/8)
- (12) Options(see Table 2) …a. Internal battery
 Type…Lithium battery, ER6VM.
 Serviceable time…One year(9000 hours), continuously operable.
 Has a battery change indicator BATT.
 b. External power source
 Input voltage …5~10 or 10~24 Vdc(see Table 2).
 Current consumption…Less than 20mA.
 c. Analog voltage output
 Output voltage …0~1V, not isolated.
 Accuracy…±1% F.S., which is added to main accuracy.
 Load resistance …Higher than 1 kohm.

§ 4. Exterminal Dimensions tolerance(±0.5mm)

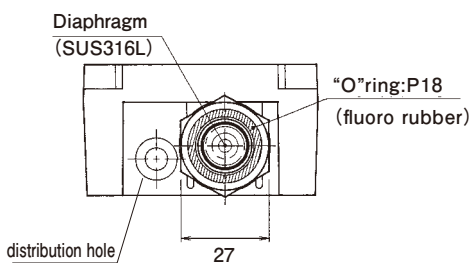
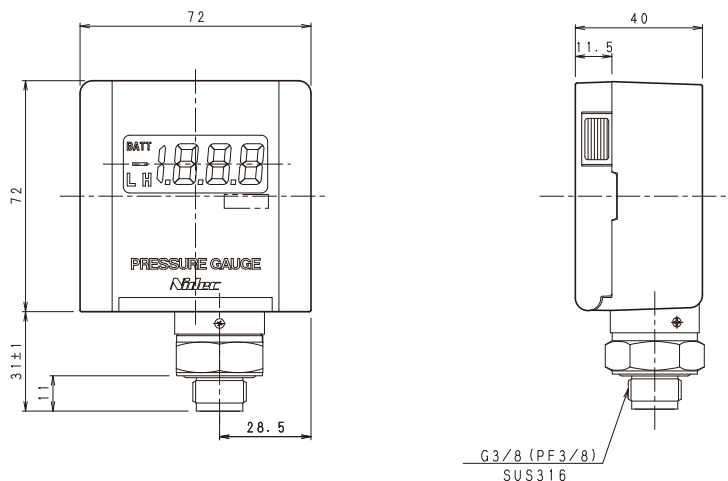

§ 5. Terminal Wiring

Proceed on the PC board inside the main body.

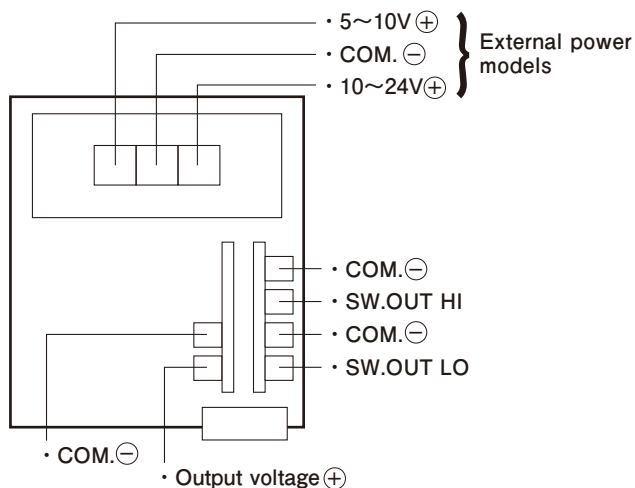

Select one of the terminal blocks for connection depending on the power voltage. Do not apply any voltage exceeding the voltage range. For output wiring, use thinner wire than AWG26.

The each common ⊖ of external power terminal and voltage output terminal are connected to the internal circuit.

§ 6. Output Type

Switch output of npn open collector type with 30Vdc and 40mA at maximum.

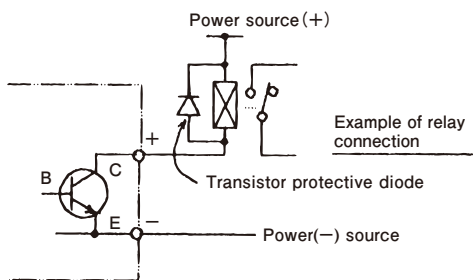

§ 7. Front Panel Controls and Features

(1) Front panel controls

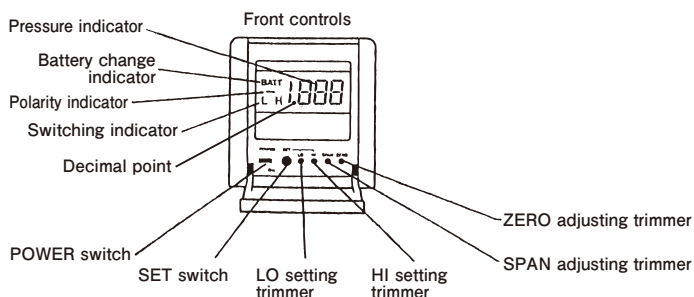

(2) Description of the features

1. Pressure indicator Shows a pressure value entered to the pressure port. Also shows a set value given with the set switch.
2. Polarity indicator Shows the negative(−) upon negative pressure.
3. POWER switch Turns on or off the power to the Pressure Gauge.
4. SET switch Selects a mode to check a HI or LO set value. If you press the SET switch once, the indication will be automatically changed in the sequence shown below. To check the LO set value, wait for around 20 seconds after pressing the SET switch.

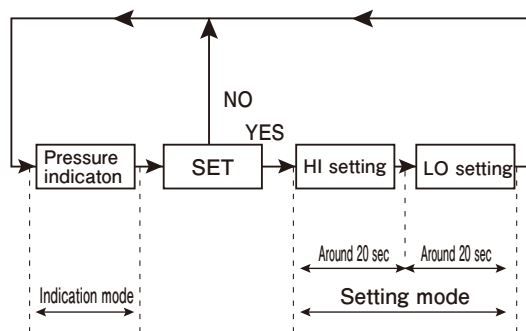

If setting ends or to interrupt setting in the course, press the SET switch again. Then the pressure will be indicated.

5. HI setting trimmer Used to adjust pressure to the HI set value that is indicated with the SET switch.
6. LO setting trimmer Used to adjust pressure to the LO set value that is indicated after the HI setting time has elapsed.
7. SPAN adjusting trimmer Used to adjust the sensitivity so that the pressure can indicate the full scale with the rated pressure applied to the pressure port. As the trimmer is calibrated, it is sealed up.
8. ZERO adjusting trimmer Used to adjust the sensor to zero. The pressure indication should be adjusted to “000” with no pressure applied.

§ 8. How to use

- (1) Make wiring by following Section 5, "Terminal Wiring."
- (2) Turn the POWER switch on. For the external power type, supply to it the power indicated on the name plate.
- (3) Check to insure that the pressure indication is zero with no pressure applied. The zero indication may be changed slightly with posture of the main body. If the indication is over 5 counts, make zero adjustment with the ZERO adjusting trimmer.
- (4) Make HI and LO settings with the SET switch and HI and LO setting trimmers (see Section 7, step 5).
- (5) Apply a pressure to the Pressure Gauge. Then it will indicate the measured value.
- (6) If the switch output is on, the Pressure Gauge will show "L" or "H".

§ 9. Warranty and Disclaimer

- 1) The warranty period of these products is one year after delivery to a designated place. The warranty mentioned here is limited to the warranty of a delivered product itself, and it does not cover consumables such as batteries. Each product has its own specifications such as durability (pressure cycles). Therefore, check with each service office.
- 2) If a failure or damage of the product occurs during the warranty period, for which we are responsible, we will promptly replace or repair the product free of charge. The warranty mentioned here means the warranty of the product itself and does not cover any damage induced by a failure of the product.
- 3) The warranty does not cover when any of the following items is applicable:
 - The failure is caused by conditions, environments, or handling not described in the catalogue and agreed specifications and other documents.
 - The product has been modified, adjusted, or repaired by a person/company other than our company after delivery.
 - The failure cannot be foreseen by the scientific and technological knowledge at the time of delivery.
 - The failure is caused by force majeure such as disasters.