

PANEL SEAL ROCKER SWITCHES

CL-LB

RoHS Compliant



Features

- Multifunction and utility switch
- The actuator that the operability is sought for from the ergonomics viewpoint.
- Illuminated type also lineup

Applications

- Function operation switches for construction machinery
- Function operation switches for automobile use

PART NUMBER DESIGNATION

CL - LB - 1 1 A 1 - S 0 0 - 21 A 0 - 0 - * * * * * * * * *

Series name

1. No. of pole(s)

2. Switching function

3. Contact rating

4. Termination / Base style

5. Illumination

11. Actuator marking

10. Panel seal

9. Actuator lens

8. Actuator

7. LED b

6. LED a

No.	Specification	Symbol		
1	No. of pose(s)	1 pole	1	
		2 poles	2	
2	Switching function	ON-OFF	1	
		(ON)-OFF	2	
		ON-ON	4	
		ON-OFF-ON	6	
		ON-OFF-(ON)	7	
		(ON)-OFF-(ON)	8	
		15A, 24V DC	A	
		20A, 12V DC	B	
3	Contact rating			
4	Terminal / Base style	#250 TAB / 8 terminal, no barriers	1	
5	Illumination	No LED	S	
		LED a, Terminal 8+ 7-	A	
		LED a, Terminal 3+ 7-	B	
		LED b, Terminal 3+ 7-	C	
		Switching function 1,2,3 not available	LED a, Terminal 1+ 7-	E
			& LED b, Terminal 3+ 7-	
		LED a, Terminal 8+ 7- & LED b, Terminal 3+ 6-		F
			LED a, Terminal 8+ 7- & LED b, Terminal 3+ 7-	G
		LED b, Terminal 8+ 7- & LED a, Terminal 8+ 7-		H
			LED a, Terminal 8+ 7- & LED b, Terminal 6+ 7-	K
		2 poles only	LED a, Terminal 3+ 6-	L
			LED b, Terminal 3+ 6-	M
		Switching function 1,2,3 not available	LED a, Terminal 1+ 4-	P
			& LED b, Terminal 3+ 6-	
6,7	6 : LED a 7 : LED b	No LED	0	
		24V DC	Red	A
		Amber	B	
		Green	C	
		White	D	
		Red(high brightness)	E	
		No LED	0	
		12V DC	Red	F
		Amber	G	
		Green	H	
		White	J	
		Red(high brightness)	K	

No.	Specification	Symbol		
8	Actuator (Viewed from Rating marking side)	Actuator2	Black	21
			Red	23
			Black	22
			Red	24
9	Actuator lens	A	No lens	A0
		B	Milky white	B1
		C	Milky white	C1
		D	Milky white	D1
		E	Milky white	E1
		F	Milky white	F1
		G	Milky white	G1
10	Panel seal	Without panel seal	0	
		With panel seal	1	
11	Actuator marking	No symbol	0	
		With symbol	see page 320.	

※ Listed here are standard specifications, but our production will take place on receipt of your orders.

■ PART NUMBER DESIGNATION

● Lock type

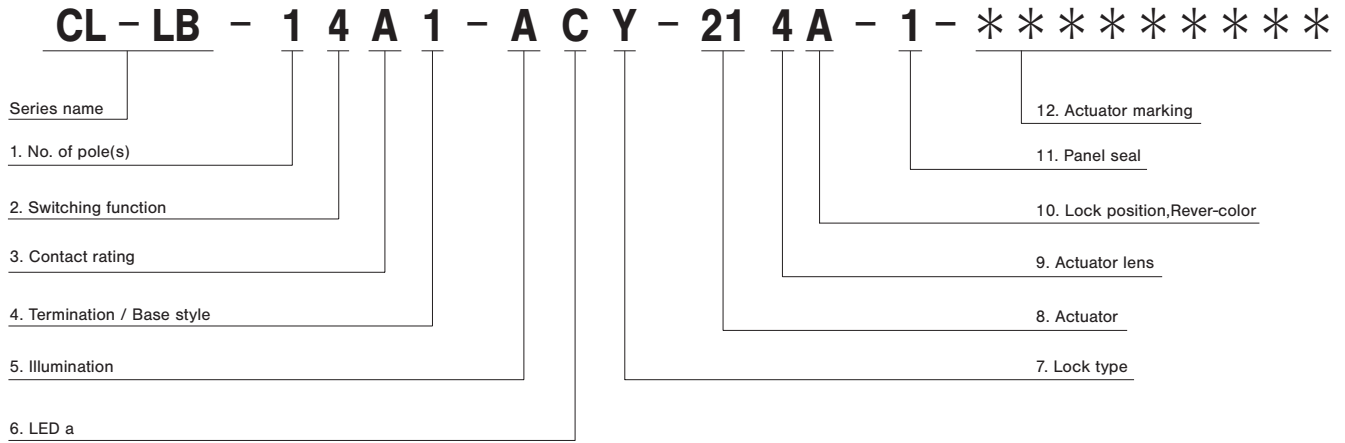

No.	Specification		Symbol	
1	No. of pose(s)	1 pole	1	
		2 poles	2	
2	Switching function	ON-OFF	1	
		ON-ON	4	
3	Contact rating	15A, 24V DC	A	
		20A, 12V DC	B	
4	Terminal / Base style	#250 TAB / 8 terminal, no barriers	1	
5	Illumination LED a : Terminal 1,4 side DC only	No LED	S	
		LED a, Terminal 8+ 7-	A	
		LED a, Terminal 3+ 7-	B	
		2 poles only LED a, Terminal 3+ 6-	L	
6	6 : LED a 7 : LED b	24V DC	No LED	0
			Red	A
			Amber	B
			Green	C
			White	D
			Red(high brightness)	E
		12V DC	No LED	0
			Red	F
			Amber	G
			Green	H
			White	J
			Red(high brightness)	K
7	Lock type		Y	

No.	Specification			Symbol
8	Actuator (Viewed from Rating marking side)	Actuator2	Black	21
9	Actuator lens		Milky white	4
10	Lock position, Rever-color	下	Gray	A
11	Panel seal		With panel seal	1
12	Actuator marking		No symbol	0
			With symbol	



STANDARD SPECIFICATIONS

Operating temp. range	-40~+85 °C
Storage temp. range	-40~+85 °C
Protection grade	Panel seal (Equivalent to IP68)
No. of pole(s)	1 pole 2 poles
Switching function	ON - OFF Standard type
	(ON) - OFF Standard type
	ON - ON Standard type
	ON - OFF - ON Standard type
	ON - OFF - (ON) Standard type
	(ON) - OFF - (ON) Standard type
	ON - OFF Lock type
	ON - ON Lock type

LIFE

Electrical life	50,000 cycles (Rated load) Switching frequency 7.5 cycles/minute
Mechanical life	150,000 cycles Switching frequency 30 cycles/minute

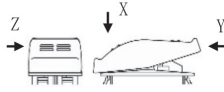
MECHANICAL CHARACTERISTICS

Switching angle	2 Positions : 18 ° 3 Positions : 9 °
Operating force	0.3~10 N
Stop strength	(Static load Applied time) : 60 s X : 49 N Y : 49 N Z : 24.5 N 
Lock strength(Lock type)	(Static load) : 98 N (Applied time) : 60 s Apply load to the top in lock state 

ELECTRICAL CHARACTERISTICS

Contact rating	15 A, 24 VDC (Resistive road) 20 A, 12 VDC (Resistive road) 100 mA, 5 VDC (Minimum rating)
Contact resistance	10 mΩ以下 (2~4 VDC, 1A) 10 mΩ Maximum (initial)
Insulation resistance	50 MΩ以上 (DC 500 V) 50 MΩ Minimum (500 VDC)
Dielection strength	AC 1,500 V 50-60 Hz 1,500 VAC 1minute

ENVIRONMENTAL CHARACTERISTICS

Vibration	(Amplitude) 1.5 mm or (Acceleration) 98 m/s ² , 10-500 Hz, 10-500-10 Hz, 15 minutes 3 directions for 12 times each
Shock	294 m/s ² , 11 ms 6 directions for 3 times each
Humidity	-10 ~ 65 °C , Relative humidity 0 ~ 96 % , 24 h for 10 cycles
High temperature exposure	85 °C , 16 h
Low temperature exposure	-40 °C , 16 h
Thermal shock	-55°C (0.5 h) ~ 85 °C (0.5 h), 5 cycles
Corrosion resistance (salt spray test)	35°C±2°C, Salt spray of concentration of 5±1% (mass ratio), Spray pressure 68.6~176kPa, spray 48h

ILLUMINATED CHARACTERISTICS

●LED max rating (25 °C)

Item	Symbol	LED					Unit
		Red	Amber	Green	White	Red(high brightness)	
Forward Curent	I _F	30	30	30	20	30	mA
Reverse Voltage	V _R	5	5	5	5	5	V

●LED electrical characteristics

Forward Curent (I _F = 20 mA)	I _F	TYP.	1.9	1.9	1.9	2.9	1.9	V
		MAX.	2.4	2.4	2.6	3.4	2.4	V

●Resistance

Connected in series with the LED inside the product.

Item	LED					Unit
	Red	Amber	Green	White	Red(high brightness)	
Resistance (24 VDC)	10	10	2.4	10	2.4	kΩ
Resistance (12 VDC)	4.7	4.7	1.1	4.7	1.1	kΩ

OUTLINE DIMENSIONS

(Unit: mm)

Standard type

※The presence or absence of the terminal depends on the number of poles, Switching function, and illumination circuit.

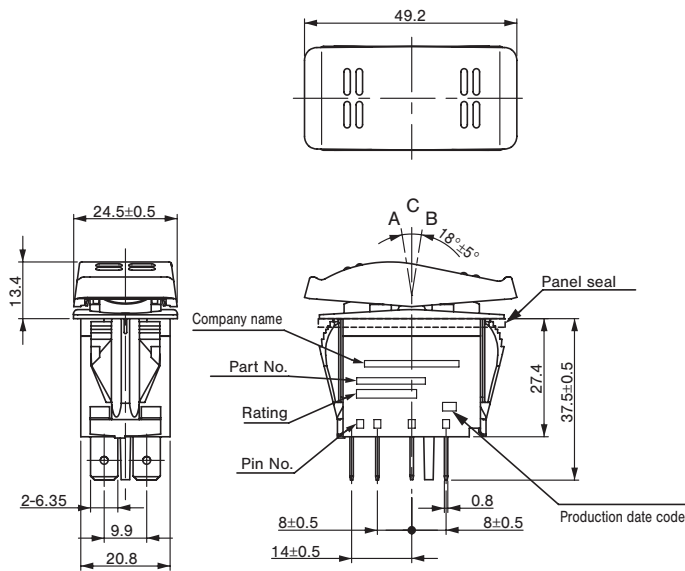

Lock type

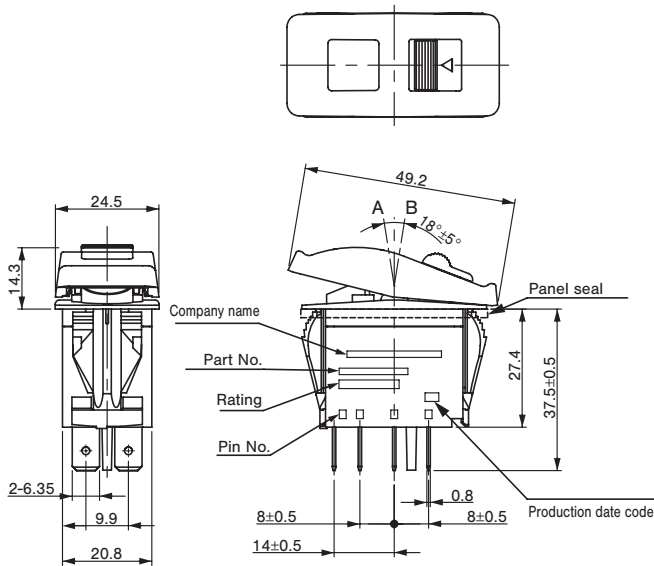

PANEL CUT-OUT DIMENSIONS

(Unit: mm)

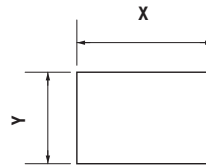

X	Y
36.8 ^{+0.1} ₀	21.0 ^{+0.1} ₀

Panel thickness	
Without panel seal	0.75 ~ 6.4
With panel seal	0.75 ~ 2.8 3.7 ~ 4.0

CIRCUIT CHARACTERISTICS

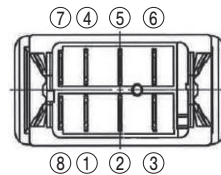

	Symbol	Position		
		A	C	B
Switching function	1	ON	-	OFF
	2	(ON)	-	OFF
Connecting terminals	1 pole	②-③	-	-
	2 poles	②-③ ⑤-⑥	-	-

Switching function	4	ON	-	ON
	6	ON	OFF	ON
	7	ON	OFF	(ON)
	8	(ON)	OFF	(ON)
Connecting terminals	1 pole	②-③	-	①-②
	2 poles	②-③ ⑤-⑥	-	①-② ④-⑤

(ON):Momentary

PACKAGING SPECIFICATIONS

- Orders will be accepted for units of 5pcs.

■ Illumination position, internal connection

● Standard type

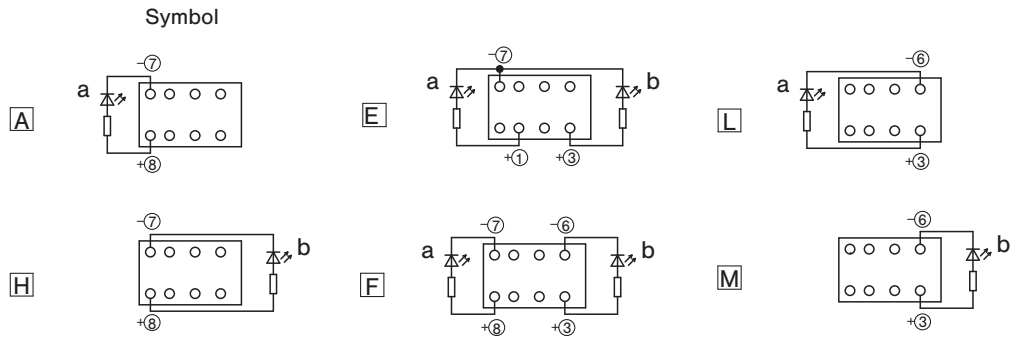
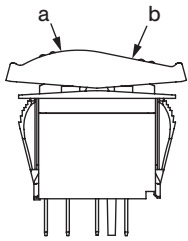

● Lock type

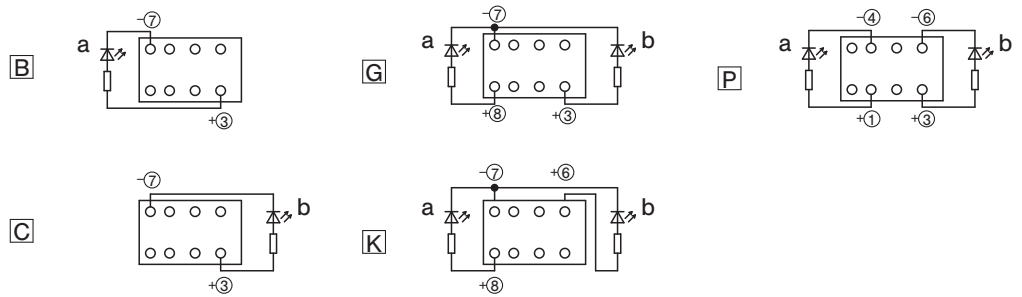
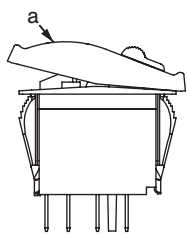

Lock type is A, B, L only

■ Accessories

● Connector

CL-LB-C1, CL-LB-C2

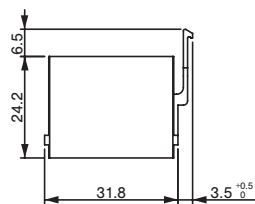
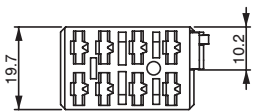

● Blindfold plug

CL-LB-H1

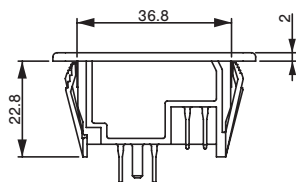
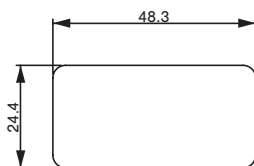

Part No.	Name of manufacturer	Applicable receptacle				Insertion direction	
		Part No.		Wire size			
		No surface treatment	Tin plating	AWG	mm ²		
CL-LB-C1	DELPHI PACKARD 58 Series	02965580	—	12	3.0	I	
		02965471	12010601	(2)16-14	(2)1.0-2.0		
		02965470	—	16-14	1.0-2.0		
		02965469	06288318	20-18	0.5-0.8		
	DELPHI PACKARD 630 Series	—	12084590	10	5.0	II	
		—	12052224	12	3.0		
		—	12015870	16-14	1.0-2.0		
		—	12020035	(2)22-18	(2)0.5-0.8		
CL-LB-C2	Tyco Electronics 250 Series	60253-1	60253-2	16-12	1.3-3	I	
		42100-1	42100-2	(2)16	(2)1.3		
		60295-1	60295-2	18-14	0.8-2.0		
		60295-1	60295-2	22-18	0.3-0.9		
	YAZAKI Corporation	7116-2090	7116-2090-02	20-14	0.5-2.0	I	
		7116-2092	7116-2092-02	12	3.0		
		JST	STI-51-250N	STI-51T-250N	20-14	0.5-2.0	I

Actuator marking model

All will be made to order. Please contact us for details.

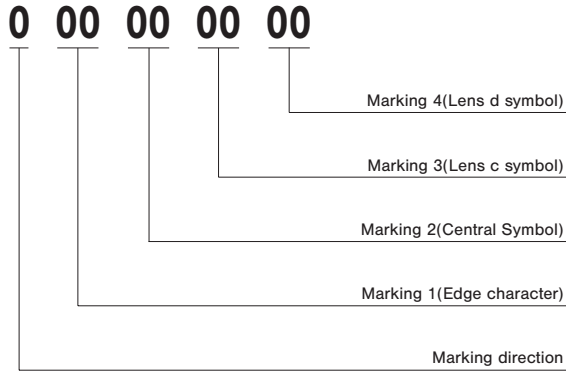

<Marking color>

Marking to actuator: White

Marking on Actuator Lens: Black

<Marking direction>

※ "A" in the figure indicates the direction of marking



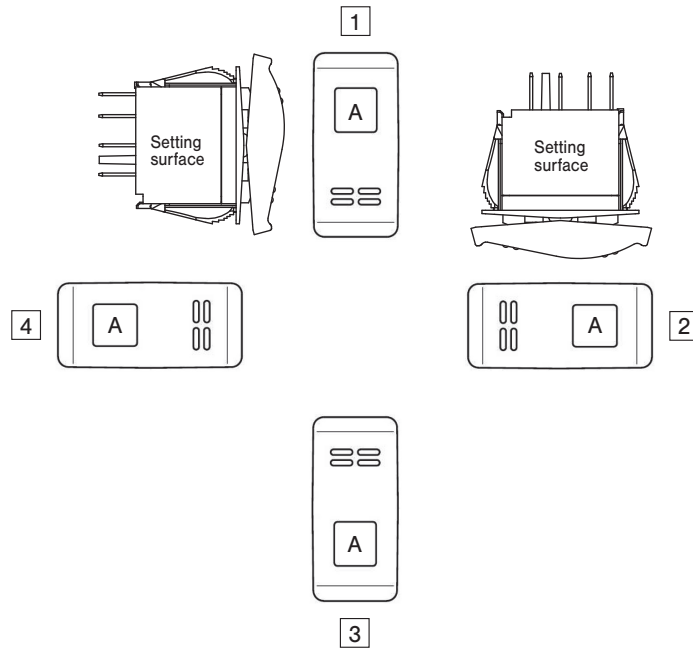



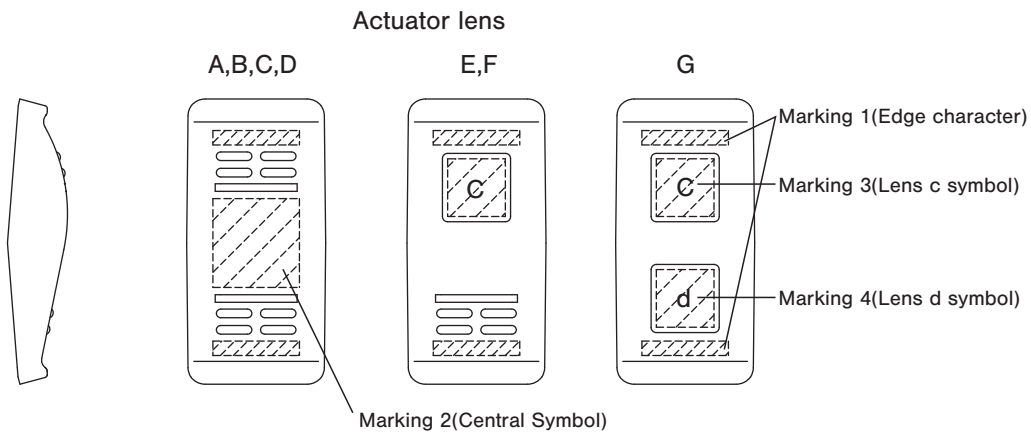











※ In the case of actuator mounting direction 21



























<Marking position>



<Marking symbol>

Symbol	Designation	Marking1 (Direction 1, 3 only)	Marking2	Marking3	Marking4
ON OFF	-	01	-	-	-
OFF ON	-	06	-	-	-
ON	-	02	-	-	-
UP DOWN	-	04	-	-	-
HIGH LOW	-	21	-	-	-
I o	-	29	-	-	-
o I	-	31	-	-	-
	Flood light 1204	-	1P	1Q	1Q
	Flood light 1204	-	8G	8H	8H
	Side marker light	-	5M	5N	5N
	Front fog light 0633	-	86	87	87
	Rear fog light 0634	-	88	89	89
	Interior compartment illumination 1421A	-	7Z	81	81
	Position lights 0456	-	8S	8T	8T
	Identification light 1141B	-	1T	1U	1U
	Loading light 2457	-	8A	8B	8B
	Windscreen washer 0088	-	1H	1I	1I
	Windscreen washer and wiper 0087	-	95	96	96
	Windscreen wiper 0086	-	1D	1E	1E
	Windscreen demisting and defrosting 0635A	-	84	85	85
	Rear window washer 0099	-	1J	1K	1K
	Rear window washer and wiper 0098	-	91	92	92
	Rear window wiper 0097	-	8J	8K	8K
	Rear window demisting and defrosting 0636A	-	9D	9E	9E
	Window lift (power-operated) 0648	-	28	29	29
	Power folding exterior mirror, vertical type 2584	-	2E	2F	2F
	Power folding exterior mirror, horizontal type 2553	-	9Z	A1	A1

Symbol	Designation	Marking1 (Direction 1, 3 only)	Marking2	Marking3	Marking4
	-	-	9V	9W	9W
	-	-	9X	9Y	9Y
	-	-	99	9A	9A
	-	-	97	98	98
	Turn signals 0084	-	8Y	8Z	8Z
	High beam 0082	-	4L	4M	4M
	Low beam 0083	-	8Q	8R	8R
	Exterior rear view mirror heating, vertical type 2470	-	2G	2H	2H
	Exterior rear view mirror heating, horizontal type 1426	-	A2	A3	A3
	Horn 0244	-	17	18	18
	Parking brake 0238	-	4S	4T	4T
	Hazard warning 0085	-	4E	4F	4F
	Fast operation 2810	-	4N	4P	4P
	Slow operation 2811	-	4Q	4R	4R
	Ventilating fan 0089	-	57	58	58
	Transmission 1166A	-	8C	8D	8D
	Interior heating 0637A	-	82	83	83
	Electrical power 2302	-	9T	9U	9U
	Lock 1656	-	8E	8F	8F
	Unlock 1656	-	8U	8V	8V
	Fuel 0245	-	9B	9C	9C
	Battery charging condition 0247	-	8W	8X	8X
	Engine shut-off 1180	-	8L	8M	8M
	Engine start	-	5P	5Q	5Q
	Engine stop	-	5R	5S	5S
	Engine, electrical preheat 1704	-	9F	9G	9G
	Engine-start aid 1547	-	9R	9S	9S

※The above is an example, please inquire the required symbols.