



**NIDEC COMPONENTS**

### Features

- Superior circuit protection
- Overcurrent and overvoltage protection
- Blocks surges up to rated limits
- High speed performance
- Small SMT package
- RoHS compliant\*
- Agency recognition:

### Applications

- Ethernet ports
- Protection modules and dongles
- Process control equipment
- Test and measurement equipment
- General electronics

## C-FAP-DT Series - C-FAP Fast Acting Protectors

### General Information

The C-FAP-DT Series of NIDEC COMPONENTS Fast Acting Protectors (C-FAP) products are very low capacitance dual unidirectional high speed surge protection components designed to protect against faults caused by short circuits, AC power cross, induction and lightning surges.

The C-FAP-DT series is a unidirectional C-FAP device; the C-FAP protector will trip in less than 1  $\mu$ s when the current reaches the maximum value in one direction only, that is when Pin 1 is positive in voltage with respect to Pin 2, and Pin 4 is positive with respect to Pin 3. No current limiting exists in the opposite polarity, and the C-FAP device appears as resistive in nature. The reverse current should not exceed the maximum trip current level of the C-FAP device. An external diode may be used to prevent reverse current in DC biased applications.

The C-FAP protector blocks surges and provides an effective barrier behind which sensitive electronics will not be exposed to large voltages or currents during surge events. After the surge, the C-FAP device resets when the voltage across the C-FAP device falls to the  $V_{reset}$  level. The C-FAP device will automatically reset on lines which have no DC bias or have DC bias below  $V_{reset}$  (such as unpowered signal lines).

The C-FAP device is provided in a surface mount DFN package and meets industry standard requirements such as RoHS and Pb Free solder reflow profiles.

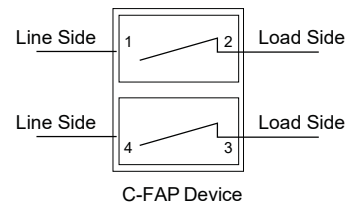

### Agency Approval

Description	
UL	File Number: E344793

### Absolute Maximum Ratings (@ $T_A = 25^\circ\text{C}$ Unless Otherwise Noted)

Symbol	Parameter	Part Number	Value	Unit
$V_{imp}$	Peak impulse voltage withstand with duration less than 10 ms	C-FAP-DT065-xxx-WH	650	V
		C-FAP-DT085-xxx-WH	850	
$V_{rms}$	Continuous A.C. RMS voltage	C-FAP-DT065-xxx-WH	300	V
		C-FAP-DT085-xxx-WH	425	
$T_{op}$	Operating temperature range		-40 to +85	$^\circ\text{C}$
$T_{stg}$	Storage temperature range		-65 to +150	$^\circ\text{C}$

### Electrical Characteristics (@ $T_A = 25^\circ\text{C}$ Unless Otherwise Noted)

Symbol	Parameter	Part Number	Min.	Typ.	Max.	Unit
$I_{trigger}$	Current required for the device to go from operating state to protected state	C-FAP-DTxxx-100-WH	100	150	200	mA
		C-FAP-DTxxx-200-WH	200	300	400	
		C-FAP-DTxxx-300-WH	300	450	600	
		C-FAP-DTxxx-500-WH	500	750	1000	
$R_{C-FAP}$	Series resistance of the C-FAP device	$V_{imp} = 650\text{ V}$ $I_{trigger}(\text{min.}) = 100\text{ mA}$	C-FAP-DT065-100-WH	8.5	9.8	$\Omega$
		$V_{imp} = 650\text{ V}$ $I_{trigger}(\text{min.}) = 200\text{ mA}$	C-FAP-DT065-200-WH	5.6	6.4	
		$V_{imp} = 650\text{ V}$ $I_{trigger}(\text{min.}) = 300\text{ mA}$	C-FAP-DT065-300-WH	4.6	5.4	
		$V_{imp} = 650\text{ V}$ $I_{trigger}(\text{min.}) = 500\text{ mA}$	C-FAP-DT065-500-WH	4.0	4.6	
		$V_{imp} = 850\text{ V}$ $I_{trigger}(\text{min.}) = 100\text{ mA}$	C-FAP-DT085-100-WH	10.3	11.9	
		$V_{imp} = 850\text{ V}$ $I_{trigger}(\text{min.}) = 200\text{ mA}$	C-FAP-DT085-200-WH	7.4	8.5	
		$V_{imp} = 850\text{ V}$ $I_{trigger}(\text{min.}) = 300\text{ mA}$	C-FAP-DT085-300-WH	6.5	7.5	
		$V_{imp} = 850\text{ V}$ $I_{trigger}(\text{min.}) = 500\text{ mA}$	C-FAP-DT085-500-WH	5.8	6.7	
$R_{match}$	Package resistance matching of the C-FAP device #1 - C-FAP device #2			$\pm 0.25$	$\pm 0.50$	$\Omega$
$t_{block}$	Time for the device to go from normal operating state to protected state				1	$\mu\text{s}$
$I_Q$	Current through the triggered C-FAP with 50 Vdc circuit voltage		0.25	0.50	1.00	mA
$V_{reset}$	Voltage below which the triggered C-FAP will transition to normal operating state		12	16	20	V
$R_{th(j-l)}$	Junction to package pads - FR4 using recommended pad layout			116		$^\circ\text{C/W}$
$R_{th(j-l)}$	Junction to package pads - FR4 using heat sink on board (6 cm <sup>2</sup> )			96		$^\circ\text{C/W}$

\*RoHS Directive 2015/863, Mar. 31, 2015 and Annex.

Specifications are subject to change without notice.

Customers should verify actual device performance in their specific applications.

# C-FAP-DT Series - C-FAP Fast Acting Protectors

NIDEC COMPONENTS

## Reference Application

The C-FAP device can be used to protect against excessive voltage surges in transformer coupled equipment, as shown in the figure below. The C-FAP protector prevents any surges from causing damage. An overvoltage protection device, such as an MOV or GDT, may be used to provide additional overvoltage protection if the surge voltage is likely to be above the maximum rating of the C-FAP device.

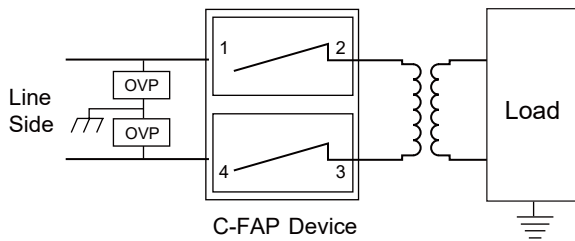

## Basic C-FAP Operation

The C-FAP device is a silicon-based, solid-state, resettable device which is placed in series with a signal path. The C-FAP device operates in approximately 1  $\mu$ s - once line current exceeds the C-FAP device's trigger current  $I_{trigger}$ . When operated, the C-FAP device restricts line current to less than 1 mA typically. When operated, the C-FAP device will block all system voltages and any other voltages including the surge up to rated limits.

After the surge, the C-FAP device resets when the voltage across the C-FAP device falls to the  $V_{reset}$  level. The C-FAP device will automatically reset on lines which have no DC bias or have DC bias below  $V_{reset}$  (such as unpowered signal lines).

If the line has a normal DC bias above  $V_{reset}$ , the voltage across the C-FAP device may not fall below  $V_{reset}$  after the surge. In such cases, special care needs to be taken to ensure that the C-FAP device will reset, otherwise an automatic or manual power down will be required. NIDEC COMPONENTS application engineers can provide further assistance.

## Performance Graphs

### V-I Characteristic - C-FAP-DT085-300-WH (Pin 2-1 & Pin 3-4)

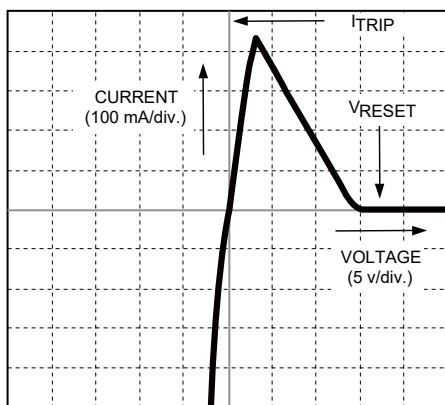

### Typical Trigger Current vs. Temperature

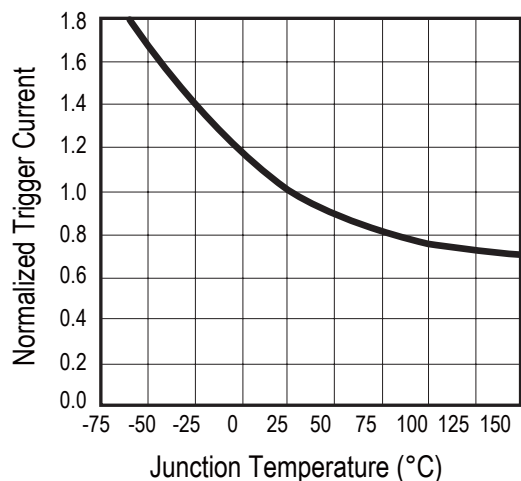

## Performance Graphs (Continued)

### Power Derating Curve

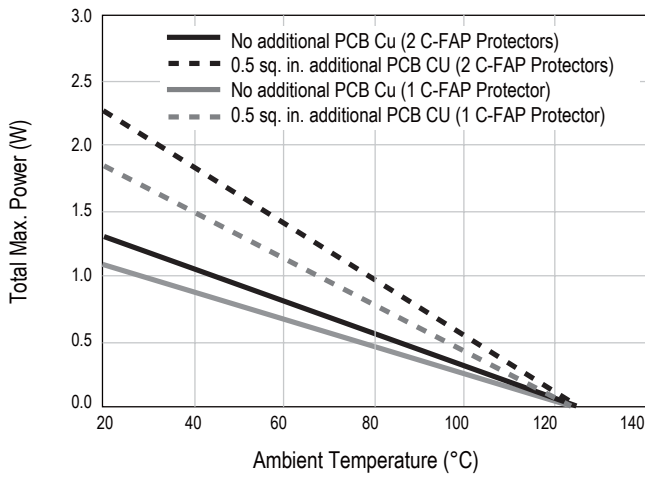

### Typical Resistance vs. Temperature

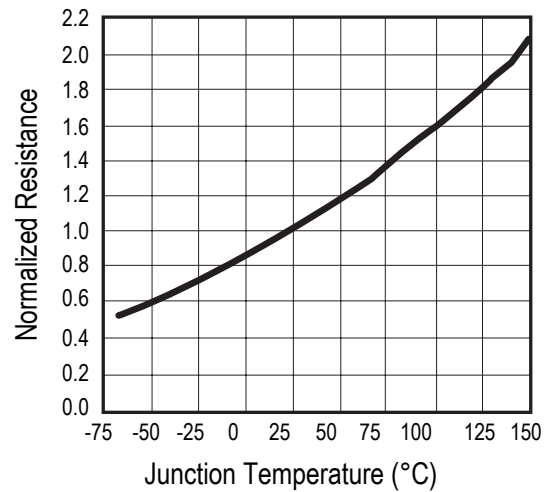

## Reflow Profile

Profile Feature	Pb-Free Assembly
Average Ramp-Up Rate (T <sub>smax</sub> to T <sub>p</sub> )	3 °C/sec. max.
Preheat	
- Temperature Min. (T <sub>smin</sub> )	150 °C
- Temperature Max. (T <sub>smax</sub> )	200 °C
- Time (t <sub>smin</sub> to t <sub>smax</sub> )	60-180 sec.
Time maintained above:	
- Temperature (T <sub>L</sub> )	217 °C
- Time (t <sub>L</sub> )	60-150 sec.
Peak/Classification Temperature (T <sub>p</sub> )	260 °C
Time within 5 °C of Actual Peak Temp. (t <sub>p</sub> )	20-40 sec.
Ramp-Down Rate	6 °C/sec. max.
Time 25 °C to Peak Temperature	8 min. max.

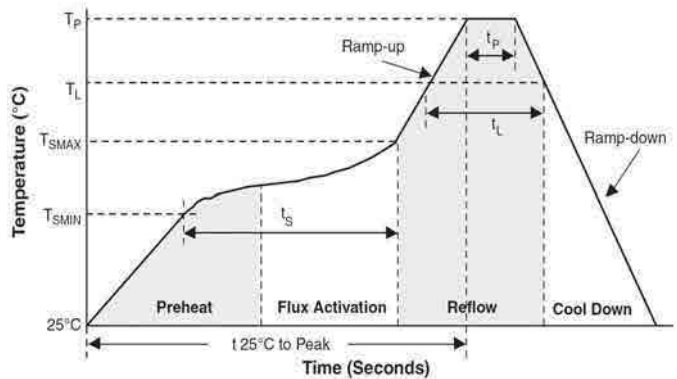

## Product Dimensions

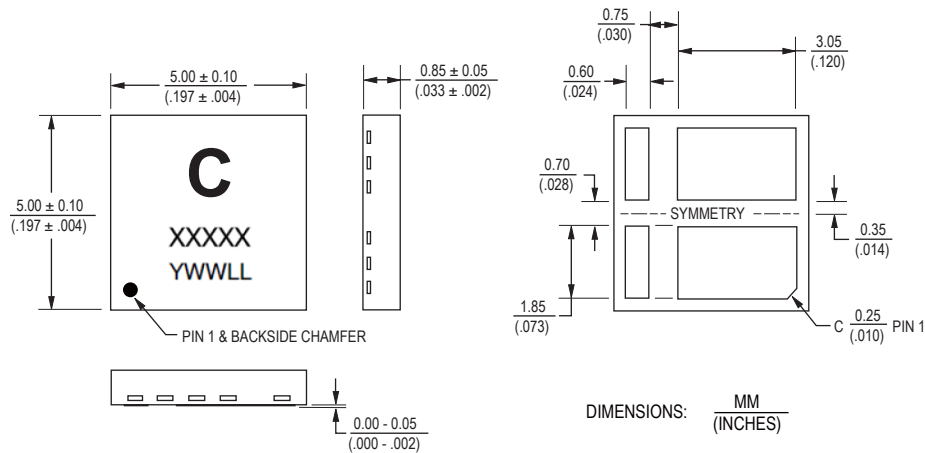

## Recommended Pad Layout

C-FAP protectors have matte-tin termination finish. The suggested layout should use Non-Solder Mask Define (NSMD). The recommended stencil thickness is 0.10-0.12 mm (.004-.005 in.) with a stencil opening size 0.025 mm (.0010 in.) less than the device pad size. As when heat sinking any power device, it is recommended that wherever possible, extra PCB copper area is allowed. For minimum parasitic capacitance, do not allow any signal, ground or power signals beneath any of the pads of the device.

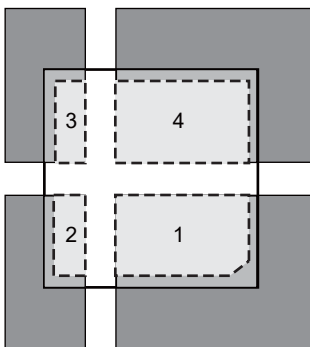

Pad Designation

Pad #	Pin Out
1	Line Side 1
2	Line Load 1
3	Line Load 2
4	Line Side 2

Dark grey areas show added PCB copper area for better thermal resistance.

## Thermal Resistance vs. Additional PCB Cu Area

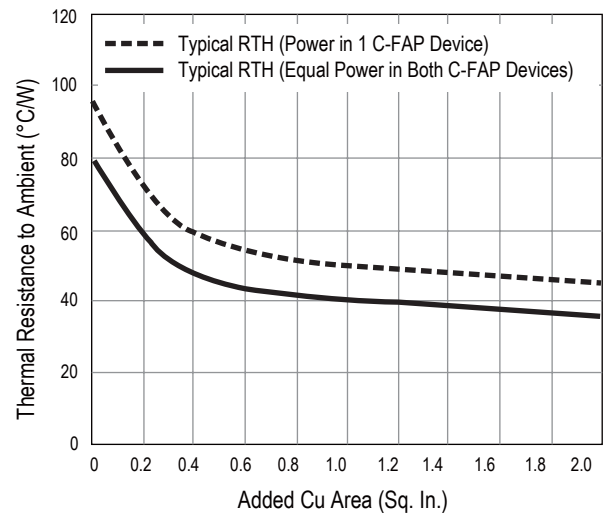

# C-FAP-DT Series - C-FAP Fast Acting Protectors

**NIDEC COMPONENTS**

## How to Order

C-FAP - DT 065 - 500 - WH

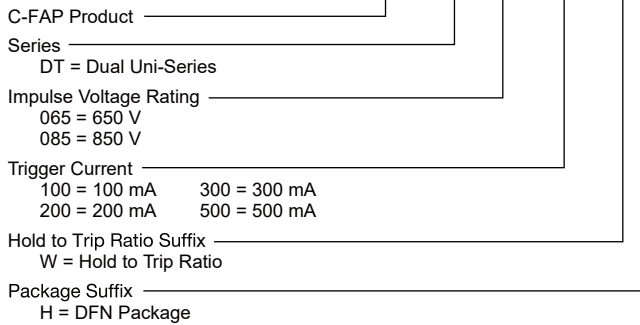

## Typical Part Marking

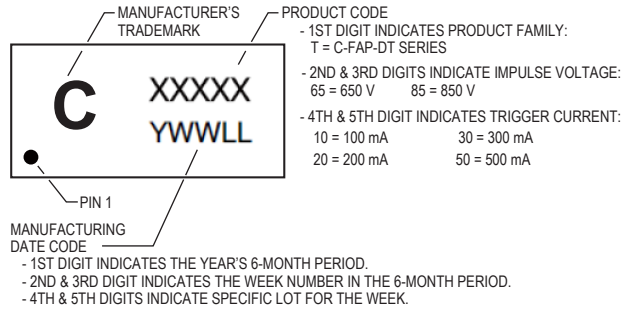

## Packaging Specifications

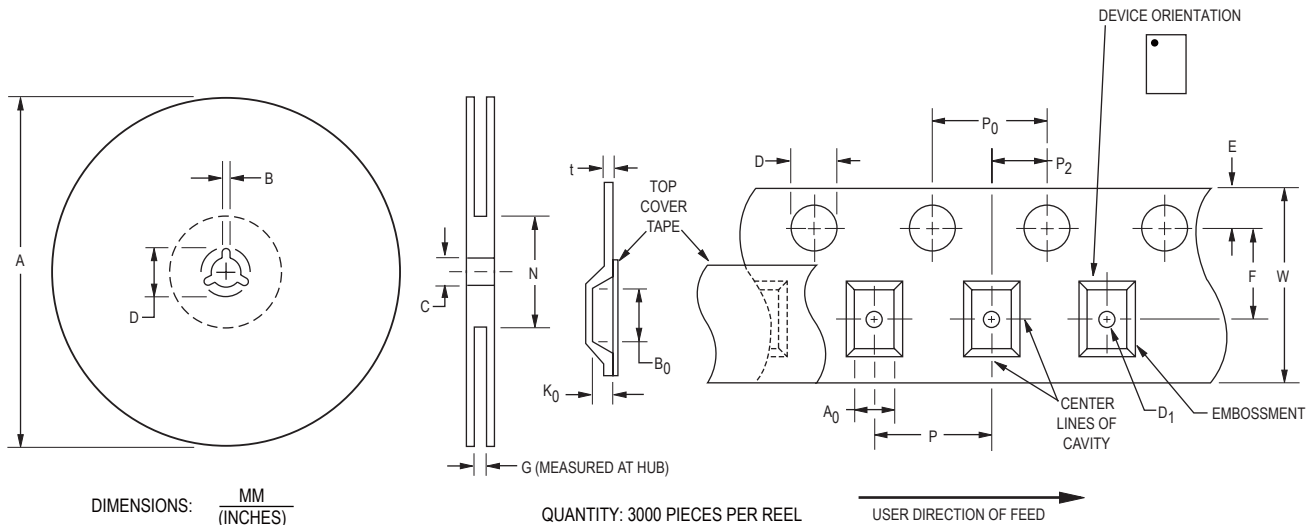

A		B		C		D		G	N
Min.	Max.	Min.	Max.	Min.	Max.	Min.	Max.	Ref.	Ref.
326	330	1.5	2.5	12.8	13.5	20.2	-	16.5	102
(12.835)	(13.002)	(.059)	(.098)	(.504)	(.531)	(.795)		(.650)	(4.016)

A0		B0		D		D1		E		F	
Min.	Max.	Min.	Max.	Min.	Max.	Min.	Max.	Min.	Max.	Min.	Max.
5.15	5.35	5.15	5.35	1.5	1.6	1.5	-	1.65	1.85	5.45	5.55
(.203)	(.211)	(.203)	(.211)	(.059)	(.063)	(.059)		(.065)	(.073)	(.214)	(.218)
K0		P		P0		P2		t		W	
Min.	Max.	Min.	Max.	Min.	Max.	Min.	Max.	Min.	Max.	Min.	Max.
1.0	1.2	7.9	8.1	3.8	4.2	1.95	2.05	0.25	0.35	11.7	12.3
(.039)	(.047)	(.311)	(.319)	(.150)	(.165)	(.077)	(.081)	(.010)	(.014)	(.461)	(.484)

Specifications are subject to change without notice.  
Customers should verify actual device performance in their specific applications

### Revision History

Date	Rev.	Reason
01/21/2011	A	Initial issue
05/15/2012	A1	Updated Performance Graphs and Packaging Specifications
02/13/2017	B	Change marking.
04/03/2023	C	Change our company name.

Revision : C  
Issue date : 04/03/2023

C-FAP-DT SERIES

Specifications are subject to change without notice.  
Customers should verify actual device performance in their specific applications.