

RoHS compliant

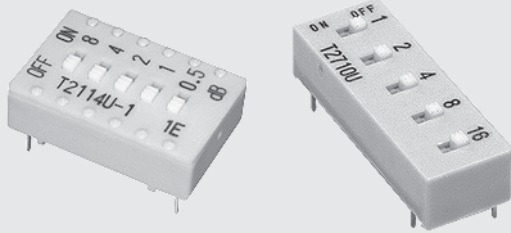

## FEATURES

- New lineup T2710 series
- Gold-plated contact provides excellent reliability
- Covering the DC to 150kHz frequency range
- Corresponds to the unbalanced circuit or balanced circuit (Balanced circuit type: T2114 series lineup only)

## APPLICATIONS

It is used for the speech equipment of 600Ω system. The high frequency attenuator can be used to adjust the voice level .

## LIST OF PART NUMBERS / SPECIFICATIONS

		T2114 series				T2710 series	
Attenuation	0.5,1,2,4,8 dB; 15.5 dB total	T2114U 600 Ω 0.5dB	T2114UW 600 Ω 0.5dB	T2114B 600 Ω 0.5dB	T2114BW 600 Ω 0.5dB	T2710U 600 Ω 0.5dB	T2710UW 600 Ω 0.5dB
	1,2,4,8,16 dB; 31 dB total	T2114U 600 Ω 1dB	T2114UW 600 Ω 1dB	T2114B 600 Ω 1dB	T2114BW 600 Ω 1dB	T2710U 600 Ω 1dB	T2710UW 600 Ω 1dB
Circuit		Unbalanced		Balanced		Unbalanced	
Impedance		600 Ω				600 Ω	
Frequency		DC ~150 kHz				DC ~150 kHz	
Rated Power		50 mW (The derating curve of rated power is a figure right below.)				50 mW (The derating curve of rated power is a figure right below.)	
Operating Temperature Range		- 25 ~ 85 °C				- 25 ~ 85 °C	
Packaging Specifications		Bulk in plastic bag	Tray packaging	Bulk in plastic bag	Tray packaging	Bulk in plastic bag	Tray packaging

## PART NUMBER DESIGNATION

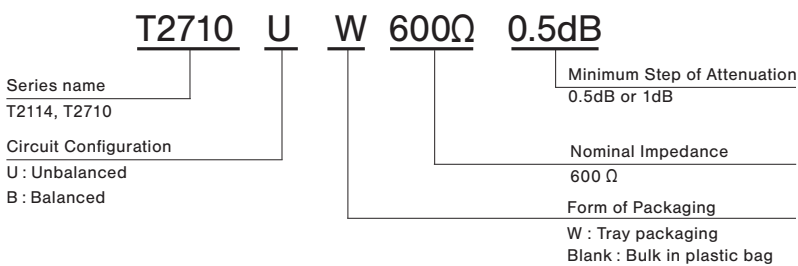

## DERATING CURVE OF RATED POWER

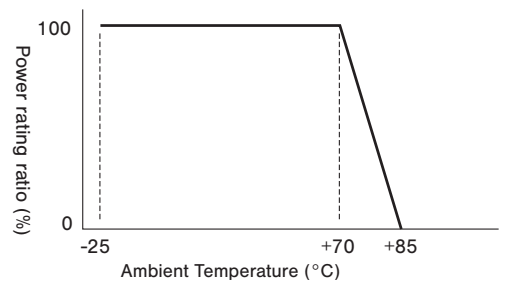

# T2114 / T2710

## STEP TYPE VARIABLE ATTENUATORS

### OUTLINE DIMENSIONS

Unless otherwise specified, tolerance :  $\pm 0.3$  (Unit : mm)

#### T2114

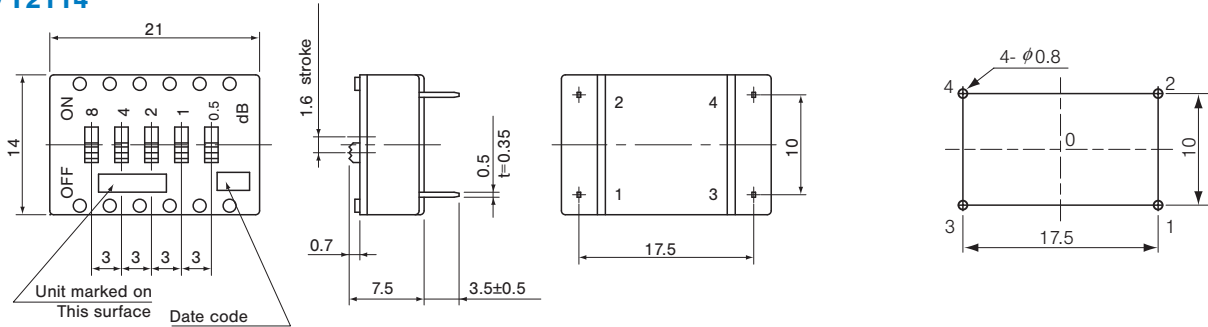

#### T2710

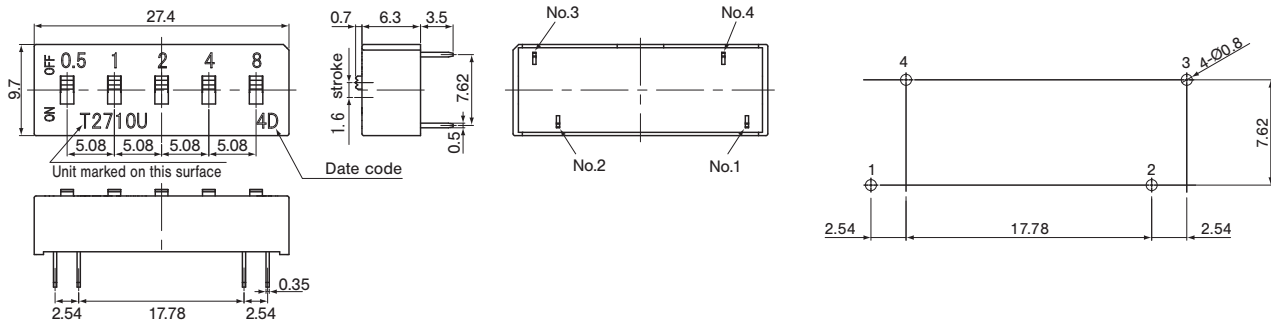

### EQUIVALENT CIRCUIT

#### T2114

U type (Unbalance)

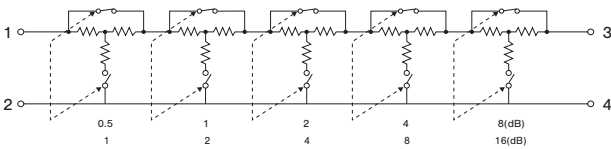

B type (Balance)

\* T2114 only

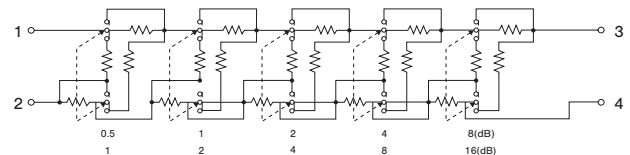

#### T2710

U type (Unbalance)

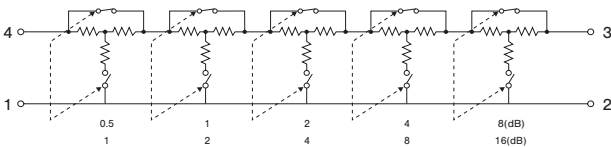

### PACKAGING SPECIFICATIONS

#### Tray packaging specifications

- Tray version is packaged in 50 pcs. per tray. Orders will be accepted for units of 50 pcs., i.e., 50,100,150 pcs. etc.
- Tray version is boxed with 10 trays (standard).

#### Tray packaging specifications (T2710)

- Tray version is packaged in 50 pcs. per tray.
- Tray version is boxed with 2 trays. Orders will be accepted for units of 100 pcs.

#### Bulk pack specifications

- The smallest unit of bulk in a plastic bag is 10 pcs. per pack.
- Boxing of bulk in a plastic bag is 2 pack. (standard 20 pcs.) per box. Orders will be accepted for unit of minimum 20 pcs.